



Camera Enclosures - Mounting Solutions - Accessories



SMARTER IMAGING FOR BETTER LIVES

Perth: (08) 9242 5411 Melbourne: (03) 9384 1775 Sydney: (02) 9905 1551

Email: sales@adeptturnkey.com.au
Web site: www.adept.net.au



Product Catalogue 2024

Valid until further notice

Protect your vision system!

autoVimation's aim is to provide simple to use products to make it possible to use machine vision cameras in any environment. Maintenance trips can be expensive, so protecting the sensitive camera equipment from damage or just manipulation is equally important.

Buildt your vision system!

The second motivation for autoVimation's products was to allow simpler installation of camera systems in a manufacturing environment - "plug and play" also for mechanics. Once the camera is mounted in an enclosure, it can be easily adjusted and robustly installed on the machine, using our mounting kits and brackets as well as our range of matching dovetail profiles. This can avoid expensive, time-consuming manufacturing of dedicated mounting frames and brackets.

What we advise both orally and in writing with regard to technical application is based on our experience and to the best of our belief; this should, however, be understood as a pointer without obligation.

Feedback welcome! Please send us an email to sales@autovimation.com, in case you will find any errors or a subject requiring more explanation!

© 2019 autoVimation GmbH, Rheinstetten, Germany - Subject to change without prior notice!



SMARTER IMAGING FOR BETTER LIVES

Perth: (08) 9242 5411 Melbourne: (03) 9384 1775 Sydney: (02) 9905 1551

Email: sales@adeptturnkey.com.au

Web site: www.adept.net.au







	Application Examples.....	4
	Why autoVimation.....	6
	Passive Cooling.....	8
	Camera Enclosures.....	10
	Laser Triangulation.....	46
	Enclosure Add-Ons.....	50
	Solutions for Dirt.....	54
	Cooling and Heating.....	57
	Mounting Solutions.....	62
	Lighting.....	79
	Accessories.....	83
	Appendix.....	86

! Application Examples















? Why autoVimation

-  **Faster completion of projects**
By eliminating the time-consuming manufacture of mechanical components.
-  **Lower project costs**
Using cost-efficient off-the-shelf items individually tailored to suit your applications.
-  **Plug & Play**
Installation and adjustment of camera systems within minutes - Easy assembly like IKEA furniture!
-  **High reliability**
All components are extremely robust and especially designed for rough industrial conditions.

Why autoVimation Enclosures and Mounting Solutions?

-  **Excellent heat dissipation**
Thanks to the patented Heat-Guide/ Quick-Lock mounting system.
-  **Flexible camera positioning**
Within the housing the camera can be moved up to the front window.
-  **Easy orientation**
Thanks to dovetail profiles on several sides its easy to adjust the working distance or to rotate the image.
-  **High IP protection and chemical resistance**
Thanks to high quality sealing materials.
-  **Mechanical robustness**
The enclosures consist of aluminium extrusion profiles.
-  **Compact dimensions**
Easy to integrate into existing machines.
-  **For nearly all environment conditions**
Thanks to a large range of accessories.
-  **Flexible mounting and positioning**
Thanks to universally combinable parts.
-  **Vibration-proof assembly**
The brackets resist displacement forces up to 2000N.
-  **Compatible to 3rd party accessories**
Because of flexible adapters.



Limited Warranty

The original autoVimation product is covered by a limited warranty of 24 months for defect free delivery according to EU regulations. autoVimations warranty refers to the constant quality of the products falling in line with the specifications according to the general terms of delivery and payment. autoVimation presuppose correct handling and treatment of the function and condition, particularly observance of the product specifications and assembly- and operating manuals. Limitations of use published, such as temperatures, are based on measurements made under the testing conditions and can therefore only serve as an indication for an actual application.

Working conditions and varying application conditions outside the sphere of influence of autoVimation shall preclude any warranty claims. autoVimation would recommend verifying whether the product is suitable for the purpose of application intended. The way the products are applied, used and processed is not a matter autoVimation is able to control, and for this reason lies solely in the customers area of responsibility. Should there nevertheless be a case for liability, it shall be restricted to the value of the product supplied by autoVimation and used by the customer for all and any damage incurred.

The suitability of the product for the user's application which regard to load capacity (long term application), conforming with temperature limits of 3rd party equipment used, the chemical durability or ageing of sealing materials, as well as the correct mechanical or electrical installation must be checked and ensured by the customer under the particular practical conditions concerned. If, within the warranty period, the product is determined to be defective (at the date of original purchase) due to improper materials or workmanship, autoVimation GmbH or their service partners will, without charge for labor or parts, repair or (at the discretion of autoVimation GmbH) replace the product or its defective parts.

The following cases are not covered by the above warranty:

- Consumable parts and parts subject to wear and tear
- Minor faults or deviations in the quality of a product which do not affect the product's value or fitness for its intended purpose
- Faults resulting from improper use (e.g. operating errors, mechanical damage, incorrect voltage)
- Any modification of autoVimation products effected by the customer or a third party, unless autoVimation has given its prior written consent to the nature and extent of the modification
- Faults due to force majeure
- Faults of which the purchaser was already aware at the time of purchase

All warranty claims become void if the product is tampered with by unauthorized persons or repair shops. Further, this warranty is voided by removal or alteration of identification labels, serial numbers or safety labels on the product or its parts. Warranty claims can be enforced in any country throughout the world in which the statutory rights of the country concerned are not in conflict with the warranty regulations. No other warranty claims or claims over and above the rights stated in these terms and conditions will be accepted.

Consumers may be entitled to statutory rights in their own countries which are not restricted by these warranty terms and conditions, as the warranty is governed by the laws of the country in which the autoVimation product was purchased by the consumer. The provisions of the UN Convention on the International Sale of Goods do not apply to this service.

Errors and technical alterations are reserved. Reprints or any kind of electronic reproduction shall only be permitted with our approval in writing. This catalogue supersedes all previous documents which herewith lose their validity.

Passive Cooling

Thanks to autoVimation's patented heat-guide / quick-lock camera mount, the camera temperature is typically reduced by 20°-25° simply by mounting the camera into the Salamander enclosure.



Due to the good heat dissipation of the mount, the outer enclosure works like a heat-sink. Therefore the camera temperature is only around 5° higher than the environment, compared with 25-30° outside the enclosure. This means the camera can be used at higher ambient temperatures, because most camera manufacturers specify the maximum operating temperature to 50°C camera temperature. Even inside the stainless steel Dolphin enclosure the passive cooling effect amounts still to a temperature reduction of 16°!

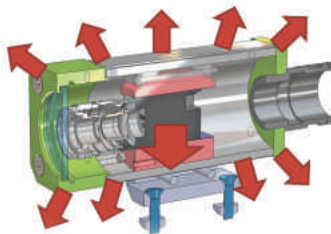



autoVimations provides also custom solutions for small series starting from 10pcs. Often we can find also an option for a single enclosure, if we will be able to customize it out of existing components. Please ask, if you will have any request!





Benefits:

- For cameras up to 30 x 30mm cross section
- Robust construction
- Compact size and
- Small dead weight
- High IP protection class
- Flexible camera positioning
- High chemical resistance
- Vibration-proof mounting
- Dome and Germanium window option
- Camera mount included
- Excellent heat dissipation
- Custom length option



Technical Details:

Max. Camera Size	30 x 30mm
Max. Lens Diameter	39mm
Inner Length	106mm (XS), 82mm (flat) 146mm (S), 122mm (flat) 176mm (M), 152mm (flat)
Dimensions (w x h) length without cable gland	50 x 50 116mm (XS), 92mm (flat) 156mm (S), 132mm (flat) 186mm (M), 162mm (flat)
Window Aperture	28mm
Standard Window Sapphire Germanium	BK7, double sided ARC Order Number: 20.000.041 Order Number: 20.000.094
Window Seal	Hytrel
Protection Class	IP66 (Nema 4)

Weight (incl. camera mount)	Ca. 350g (XS), 280g (flat) Ca. 420g (S), 350g (flat) Ca. 465g (M), 395g (flat)
Enclosure Material	Anodized Aluminum
Enclosure Seals	NBR
Cable Gland Aperture (max. connector size)	20mm (Rear Wall A) 16.5mm (Rear Wall B) 20.5mm (Rear Wall C)
Cable Diameter	4-6.5mm (Rear Wall B) Self drilling (Rear Wall C)
Cable Gland Seal	TPE



The camera mount guarantees excellent heat dissipation



Order Numbers:

Product ID	Camera Height	Enclosure Type	Rear Wall/Front Lid	Length	
2	29 = 2.9 30 = 3.0	0	Front Lid	XS: 080 S: 120 M: 150	
			standard		
			0 Rear Wall A		5
			1 Rear Wall B		6
			2 Rear Wall C	7	
Surcharge Colibri Custom Length: 20.000.045			Order separately: Surcharge cam mount Flir Firefly: 20.000.083		

Example: 22.905.120 | Colibri S | camera height 29mm | flat front lid | rear wall A



Dome Window for Fisheyes

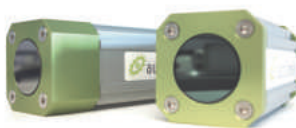

Germanium Windows for IR cameras



Special Mount for Flir FireFly

Accessories:

Product	Image	Order No.	Product	Image	Order No.	Product	Image	Order No.
Air Nozzle		50.100.023	28mm PA Tube		20.000.006	Mounting Kit 27		5.270.000
Deflection Mirror 90°		20.020.004 + 10.062.979	Mounting Kit 21		5.210.000	Mounting Kit 28		5.280.000
30/40mm Bracket		10.062.979	Mounting Kit 22		5.220.000	Mounting Kit 29		5.290.000
Surcharge Dome		20.000.092	Mounting Kit 24/24m		5.240.000 5.240.000m			



Benefits:

- For cameras up to 40 x 40mm cross section
- Robust construction
- Compact size
- High IP protection class
- Flexible camera positioning
- High chemical resistance
- Vibration-proof mounting
- Camera mount included
- Excellent heat dissipation
- Special version for Tamron MP3010



Technical Details:

Max. Camera Size (w x h)	40 x 40mm 29 x 47mm	Weight (without camera mount)	Approx. 660g (Size XS) Approx. 850g (Size S) Approx. 1070g (Size M) Approx. 1200g (Size L)
Max. Lens Diameter	55mm (in profile) 52mm (in front lid)	Enclosure Material	Anodized Aluminum
Inner Length	94 (Size XS) 136 (Size S) 189 (Size M) 219 (Size L)	Enclosure Seals	NBR
Enclosure Dimensions (w x h x l, without cable gland)	66 x 66 x 108mm (Size XS) 66 x 66 x 150mm (Size S) 66 x 66 x 203mm (Size M) 66 x 66 x 233mm (Size L)	Cable Gland Aperture (max. connector size)	22mm (Rear Wall A) 13.5mm (Rear Wall B) 16.5mm (Rear Wall B) 26.5mm (Rear Wall C)
Window Aperture	45mm	Cable Diameter	4-6.5mm (Rear Wall B) Self drilling (Rear Wall C)
Standard Window	BK7, double sided ARC	Cable Gland Seal	TPE
IR Mirror	Order Number: 20.000.010		
Sapphire	Order Number: 20.000.016		
Germanium	Order Number: 20.000.017		
Acrylic, uncoated	Order Number: 20.000.058		
Acrylic, double sided ARC	Order Number: 20.000.029		
Window Seal	FKM		
Protection Class	IP66 (Nema 4) IP67 (Nema 6)		

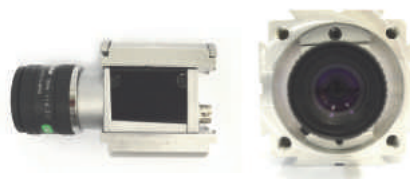

The mount guarantees excellent heat dissipation

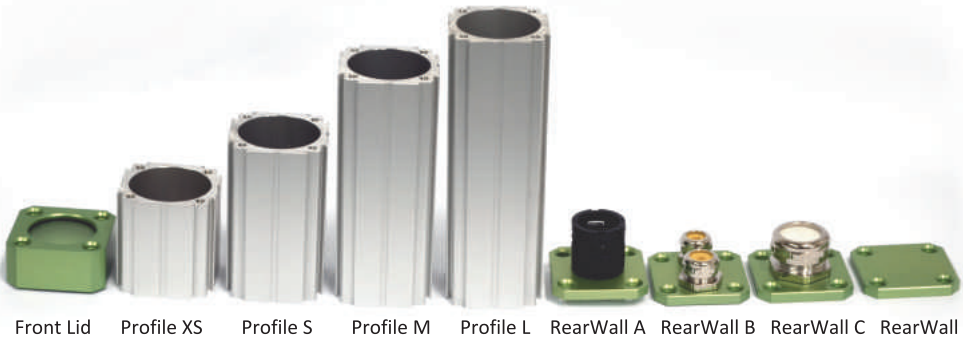

Order Numbers:

			Salamander S für Tamron MP3010	100.010.602	
Product ID	Camera Height	Camera Length	Enclosure Type	Rear Wall Type	Length
2	29: 0 30: 1 31: 2 32: 3 33: 4 34: 5 35: 6 36: 7 38: 8 40: 9	< 50mm: 3 < 74mm: 5 < 92mm: 7	1	A: 0 B: 1 C: 2 D: 3	XS: 070 S: 139 M: 192 L: 222

Example: 20.312.192 | Salamander M | camera height 29mm | camera length <50mm | rear wall C

Accessories:

Product	Image	Order No.	Product	Image	Order No.	Product	Image	Order No.
Air Nozzle		50.100.025	Cooling Module		60.100.010	Mounting Kit 2		5.020.000
2" Wind Curtain		50.100.010	El. Heating Plate		70.100.018	Mounting Kit 6		5.060.000
Tube for W. Curtain		50.100.017	Orca Adapter		15.030.001	Mounting Kit 7		5.070.000
Pneumatic Shutter		50.200.010	Sun Roof Size S, M, L		20.010.001 20.010.002 20.010.003	Mounting Kit 9		5.090.000
Deflection Mirror 90°		20.020.004	LaserMount 19 or 20mm		14.100.019 14.100.020	Mounting Kit 10		5.100.000
30/60mm Extension		15.015.030 15.015.060	Corrugated Tube 28mm		20.000.006	Mounting Kit 15		5.150.000
60mm Side Exit		15.015.061	Mounting Kit 1		5.010.000	Mounting Kit 16/16m		5.160.000 5.160.000m
Position Ring		20.020.003				Mounting Kit 17/17m		5.170.000 5.170.000m



Benefits:

- For Flir Ax5 (new and old version)
- For cameras with special shape
e.g. Tamron MP1010M
- Compact size
- Small dead weight
- High IP protection class
- Flexible camera positioning
- High chemical resistance
- Vibration-proof mounting
- Camera mount included
- Good heat dissipation



Technical Details:

Max. Camera Size (w x h)	39 x 53mm	Weight (without camera mount)	Approx. 660g (Ax5)
Max. Lens Diameter	55mm	Enclosure Material	Anodized Aluminum
Inner Length	178mm (Ax5)	Enclosure Seals	NBR
Enclosure Dimensions (w x h x l, without cable gland)	66 x 66 x 190mm (Ax5)	Cable Gland Aperture (max. connector size)	22mm (Rear Wall A)
Window Aperture	45mm	Cable Diameter	Self drilling (Rear Wall C)
Standard Window	BK7, double sided ARC	Cable Gland Seal	TPE
IR Mirror	Order Number: 20.000.010		
Saphire	Order Number: 20.000.016		
Germanium	Order Number: 20.000.017		
Acrylic, uncoated	Order Number: 20.000.058		
Acrylic, double sided ARC	Order Number: 20.000.029		
Window Seal	FKM		
Protection Class	IP66 (Nema 4)		



Special mount for the new Flir Ax5 camera
with lenses from 7.5mm to 19mm focal length



Gecko for Ax5 V2016



Custom Color Gecko for Tamron MP1010M

Order Numbers (please specify camera type!):

Product Description	Order Number
Gecko, Germanium Window, Rear Wall C, for Flir Ax5 up to 19mm focal length	24.022.155
Gecko, BK7 window double sided ARC, Rear Wall A, custom length up to 300mm	24.020.XXX
Gecko, BK7 window double sided ARC, Rear Wall C, custom length up to 300mm	24.022.XXX

Accessories:

Product	Image	Order No.	Product	Image	Order No.	Product	Image	Order No.
Air Nozzle		50.100.025	Sun Roof Size S		20.010.001	Mounting Kit 6		5.060.000
2" Wind Curtain		50.100.010	Sun Roof Size M		20.010.002	Mounting Kit 7		5.070.000
Tube Wind Curtain 2"		50.100.017	Sun Roof Size L		20.010.003	Mounting Kit 9		5.090.000
Pneumatic Shutter		50.200.010	Corrugated Tube 28mm		20.000.006	Mounting Kit 10		5.100.000
Deflection Mirror 90°		20.020.004	Orca Adapter		15.030.002	Mounting Kit 15		5.150.000
Cooling Module		60.100.010	Mounting Kit 1		5.010.000	Mounting Kit 16/16m		5.160.000 5.160.000
El. Heating Plate		70.100.018	Mounting Kit 2		5.020.000	Mounting Kit 17/17m		5.170.000 5.170.000m



Benefits:

- Electro-polished V4A stainless steel AISI 316L
- For cameras up to 40 x 40mm cross section
- Robust construction
- Compact size
- High IP protection class
- Flexible camera positioning
- High chemical resistance
- Vibration-proof mounting
- Camera mount included
- Good heat dissipation
- Easy window replacement



Technical Details:

Max. Camera Size (w x h)	40 x 40mm 29 x 47mm	Weight (without camera mount)	Approx. 1700g (Size S) Approx. 2200g (Size M)
Max. Lens Diameter	55mm (in profile) 52mm (in front lid)	Enclosure Material	Electro-polished V4A stainless steel AISI 316L
Inner Length	101 (Size S) 151 (Size M)	Enclosure Seals	EPDM
Enclosure Dimensions (d x l, without cable gland)	69 x 115mm (Size S) 69 x 165mm (Size M)	Cable Gland Aperture (max. connector size)	18.5mm
Window Aperture	45mm	Cable Diameter	Self drilling
Standard Window	BK7, double sided ARC	Cable Gland Seal	TPE
IR Mirror	Order Number: 20.000.010		
Saphire	Order Number: 20.000.016		
Germanium	Order Number: 20.000.017		
Acrylic, uncoated	Order Number: 20.000.058		
Acrylic, double sided ARC	Order Number: 20.000.029		
Window Seal	FKM		
Protection Class	IP66 (Nema 4) IP67 (Nema 6)		



The mount guarantees good heat dissipation



Front Lid

Profile S

Profile M

RearWall

Mount

Order Numbers:

Product ID	Camera Height	Camera Length	Enclosure Type	Length
2	29: 0 30: 1 31: 2 32: 3 33: 4 34: 5 35: 6 36: 7 38: 8 40: 9	< 50mm: 3 < 74mm: 5 < 92mm: 7	30	S: 110 M: 160

Example: 20.330.160 | Feuersalamander M | camera height 29mm | camera length <50mm

Accessories:

Product	Image	Order No.	Product	Image	Order No.	Product	Image	Order No.
Position Ring		20.020.003	Mounting Tool		90.000.004	Mount		5.120.000
2" Wind Curtain		50.100.010	Tube for W. Curtain		50.100.017			



Benefits:

- V4A stainless steel AISI 316L
- Consequent hygienic design
- IP69K protection class
- Compact size
- Flexible camera positioning
- High chemical resistance
- Vibration-proof mounting
- Camera mount included
- Good heat dissipation



Technical Details:

Max. Camera Size (w x h)	40 x 40mm 29 x 47mm
Max. Lens Diameter	55mm
Inner Length	148mm (S) 188mm (M) 218mm (L)
Enclosure Dimensions (D x L, without gland and 100mm handle)	63 x 167mm (S) 63 x 207mm (M) 63 x 237mm (L)
Window Aperture	45mm
Standard Window Lid for Special Windows	BK7, double sided AR Order Number: 80.005.017
IR Mirror	Order Number: 20.000.010
Sapphire	Order Number: 20.000.016
Germanium	Order Number: 20.000.017
Acrylic, uncoated, FDA	Order Number: 20.000.032
Acryl, double sided AR	Order Number: 20.000.029
Window Seal	EPDM
Protection Class (with hygiene cable gland)	IP69K

Weight (without camera mount, varies depending on exit)	Ca. 1360g (S) Ca. 1510g (M) Ca. 1710g (L)
Enclosure Material	Electro polished V4A stainless steel AISI 316L
Enclosure Seals	EPDM
Sealing Area of the Hygiene Cable Gland	M25: 15-18mm M32: 20-25mm (with M25 Adapter only)
Cable Gland Seal	TPU



The mount guarantees good heat dissipation



Cable Exit and Options

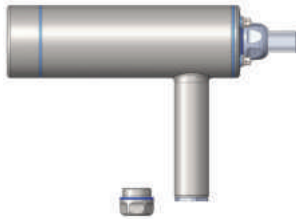

- Order Number: 2X.X70.138 - Dolphin S, IP69K
- BK7 window
 - M25 hygiene cable gland rear
 - M25 blind plug sideways

Options:

- 80.007.002 hygienic tube 25x19mm, price per meter
- 80.005.014 surcharge for M25 hygiene blind plug sideways

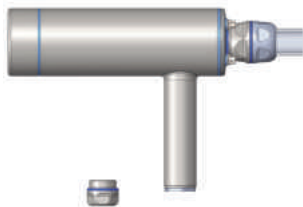

- Order Number: 2X.X71.138 - Dolphin S, IP69K
- BK7 window
 - M25 hygiene cable gland rear
 - M25 blind plug sideways

Options:

- 80.007.001 hygienic tube 18x13mm, price per meter
- 80.005.014 surcharge for M25 hygiene blind plug sideways

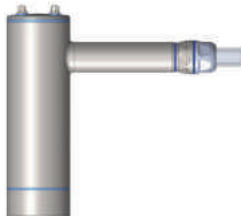

- Order Number: 2X.X80.138 - Dolphin S, IP69K
- BK7 Fenster
 - Closed rear wall
 - M25 hygiene cable gland sideways

Options:

- 80.007.002 hygienic tube 18x13mm, price per meter

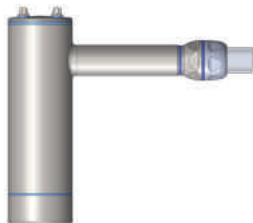

- Order Number: 2X.X81.138 - Dolphin S, IP69K
- BK7 window
 - Closed rear wall
 - M32 hygiene cable gland sideways

Options:

- 80.007.002 hygienic tube 25x19mm, price per meter

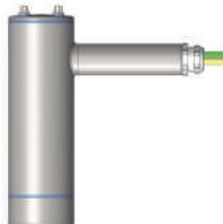

- Order Number: 2X.X82.138 - Dolphin S, IP69K
- BK7 window
 - Closed rear wall
 - M25 stainless steel blind plug sideways



Using the Hygienic Building Kit you can install cameras, lasers and cables under IP69K protection

Order Numbers:

ID	Camera Height	Camera Length	Cable Exit	Cable Gland	Length
2	29: 0 30: 1 31: 2 32: 3 33: 4 34: 5 35: 6 36: 7 38: 8 40: 9	< 50mm: 3 < 74mm: 5 < 92mm: 7	rear: 7 side: 8	M25 hygiene IP69K: 0 M32 hygiene IP69K: 1 M25 standard IP66/IP67: 2 (side exit only)	S: 138 M: 188 L: 218

Example: 20.370.138 | Dolphin S | camera height 29mm | camera length <50mm | M25 hygiene gland rear

Accessories:

Product	Image	Order No.	Product	Image	Order No..	Product	Image	Order No..
M25 Gland Hygiene		80.005.003	M32 Gland Hygiene		80.005.004	M40 Gland Hygiene		80.005.005
M32 Adapter		80.005.002	M25 Hyg. Blind Plug		80.005.010	M25 Nut M32 Nut M40Nut		80.005.006 80.005.007 80.005.008
18x13 PUR Tube		80.007.001	25x19 PUR Tube		80.007.002	M25 Adapter		80.005.001
Position Ring		20.020.003	30mm Dol. Extension		80.005.030	Monting Tool		80.006.101
90° Tube Connector		80.006.002	Mount Standard		80.006.006	Hygienic Rear Mount		80.006.000
90° Hygienic Connector		80.006.001	Hygienic Mount Foot		80.006.004	Hygienic T-Piece		80.006.007



Benefits:

- V4A stainless steel AISI 316L
- Consequent hygienic design
- IP69K protection class
- Compact size
- Flexible camera positioning
- High chemical resistance
- Vibration-proof mounting
- Camera mount included
- Good heat dissipation



Technical Details:

Max. Camera Size (w x h)	62 x 62mm (depending on edge radius)
Max. Lens Diameter	85mm
Inner Length (Size, Clamping Length)	138mm (S, 84mm) 188mm (M, 134mm) 258mm (L, 204mm)
Enclosure Dimensions (D x L, without gland and 100mm handle)	93 x 155mm (S) 93 x 205mm (M) 93 x 275mm (L)
Window Aperture	66mm
Standard Window Germanium Acrylic, uncoated, FDA Acryl, double sided AR	BK7, double sided AR Order Number: 20.000.018 Order Number: 20.000.003 Order Number: 20.000.033
Window Seal	EPDM
Protection Class (with hygiene cable gland)	IP69K

Weight (without camera mount, varies depending on exit)	Ca. 1900g (S) Ca. 2300g (M) Ca. 3000g (L)
Enclosure Material	Electro polished V4A stainless steel AISI 316L
Enclosure Seals	EPDM
Sealing Area of the Hygiene Cable Gland	M25 (side): 15-18mm M32: 20-25mm
Cable Gland Seal	TPU



The mount guarantees good heat dissipation



Cable Exit and Options



- Order Number: 2X.X71.180 - Shark M, IP69K
- BK7 window
 - M32 hygiene cable gland rear
 - M25 blind plug sideways

Options:

- 80.007.002 hygienic tube 25x19mm, price per meter
- 80.005.014 surcharge for M25 hygiene blind plug sideways

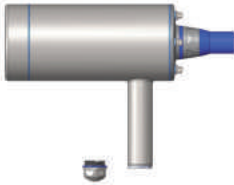

- Order Number: 2X.X72.180 - Shark M, IP69K
- BK7 window
 - Closed rear wall
 - M25 hygiene cable gland rear

Options:

- 80.007.003 hygienic tube 26.5x21mm, price per meter
- 80.005.014 surcharge for M25 hygiene blind plug sideways



- Order Number: 2X.X80.180 - Shark M, IP69K
- BK7 window
 - Closed rear wall
 - M25 hygiene cable gland sideways

Options:

- 80.007.001 hygienic tube 18x13mm, price per meter



- Order Number: 2X.X81.180 - Shark M, IP69K
- BK7 window
 - Closed rear wall
 - M32 hygiene cable gland sideways

Options:

- 80.007.002 hygienic tube 25x19mm, price per meter



- Order Number: 2X.X82.180 - Shark M, IP66+IP67
- BK7 window
 - Closed rear wall
 - M25 stainless steel cable gland sideways

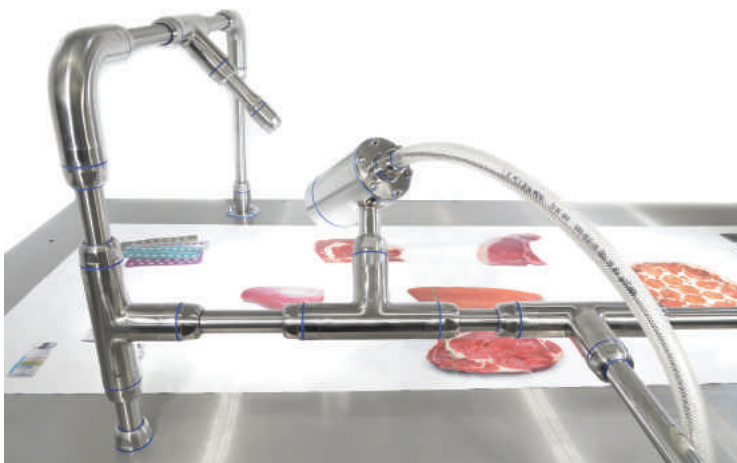

Using the Hygienic Building Kit you can install cameras, lasers and cables under IP69K protection

Order Numbers (please specify camera type):

ID	Camera Type	Cable Exit	Cable Gland	Length
2	X.X	rear: 7 sideways: 8	M25 hygiene IP69K: 0 (side exit only) M32 hygiene IP69K: 1 M25 standard IP66/67: 2 (side exit only) M25 hygiene IP69K: 2 (rear exit only)	S: 130 M: 180 L: 250

Example: 2X.X81.180 | Shark M | M32 hygiene cable gland sideways

Accessories:

Product	Image	Order No.	Product	Image	Order No..	Product	Image	Order No..
M25 Gland Hygiene		80.005.003	M32 Gland Hygiene		80.005.004	M40 Gland Hygiene		80.005.005
M25 Adapt. M32 Adapt.		80.005.001 80.005.002	M25 Hyg. Blind Plug		80.005.010	M25 Nut M32 Nut M40Nut		80.005.006 80.005.007 80.005.008
18x13 PUR Tube		80.007.001	25x19 PUR Tube		80.007.002	26.5x21 PU Tube		80.007.003
Position Ring		20.020.002	30mm Extension		80.020.030	Monting Tool		80.006.101
90° Tube Connector		80.006.002	Mount Standard		80.006.006	Hygienic Rear Mount		80.006.000
90° Hygienic Connector		80.006.001	Hygienic Mount Foot		80.006.004	Hygienic T-Piece		80.006.007



Benefits:

- For cameras up to 61 x 61mm cross section
- Robust construction, high IP protection class
- Flexible camera positioning
- High chemical resistance
- Vibration-proof mounting
- Excellent heat dissipation
- Integration of ring lights possible
- Dome window option
- Twin window Ge/BK7 for Flir A50/70 option



Technical Details:

Max. Camera Size (w x h)	61 x 61mm
Max. Lens Diameter	85mm (in profile) 78mm (in front lid)
Inner Length	130mm (Size S) 180mm (Size M) 250mm (Size L) 335mm (Size XL)
Enclosure Dimensions (w x h x l, without cable gland)	96 x 96 x 144mm (Size S) 96 x 96 x 194mm (Size M) 96 x 96 x 264mm (Size L) 96 x 96 x 349mm (Size XL)

Weight (without camera mount)	Approx. 1050g (Size S) Approx. 1200 (Size M) Approx. 1550g (Size L) Approx. 2050g (Size XL)
Enclosure Material	Anodized Aluminum
Window/Enclosure Seals	EPDM

Cable Gland Aperture (max. connector size)	22mm (Rear Wall A) 26.5mm (Rear Wall C)
Cable Diameter	Self drilling (Rear Wall C)
Cable Gland Seal	TPE

Window Aperture	45mm (2" window) 65mm (3" window)
Standard Window	BK7, double sided ARC
2" IR Mirror	Order Number: 20.000.010
3" IR Mirror	Order Number: 20.000.064
2" Sapphire	Order Number: 20.000.016
2" Germanium	Order Number: 20.000.017
3" Germanium	Order Number: 20.000.018
Twin window Ge/BK7	Order Number: 20.000.114
2" Acrylic, double sided AR	Order Number: 20.000.029
3" Acrylic, double sided AR	Order Number: 20.000.033

Protection Class	IP66 (Nema 4) IP67 (Nema 6)
-------------------------	--------------------------------



The mount guarantees excellent heat dissipation



2" Lid 3" Lid Dome Lid Profile S Profile M Profile L RearWall A RearWall C RearWall D RearWall E

Order Numbers (please specify the camera type for each order!):

Product ID	Camera Type	Enclosure ID	2" Window	Rear Wall Type	3" Window	Length
2	X.X please specify camera type!	4	A: 0 C: 1 D: 2		A: 5 C: 6 D: 9	S: 130 M: 180 L: 250 XL: 335

Example: 2X.X46.180 | Orca M | 3" window | rear wall C

Accessories:

Product	Image	Order No.	Product	Image	Order No.	Product	Image	Order No.
Air Nozzle		50.100.025	Position Ring		20.040.002	Mounting Kit 1		5.010.000
2"/3" Wind Curtain		50.100.010 50.100.011	Cooling Module		60.100.010	Mounting Kit 2		5.020.000
Tube 2"/3" wind curtain		50.100.017 50.100.018	El. Heating Plate		70.100.018	Mounting Kit 6		5.060.000
Meganova Ring Light		See data sheet	Sun roof Size S		20.011.001	Mounting Kit 7		5.070.000
Shutter 2" Shutter 3"		50.200.020 50.200.021	Size M Size L		20.011.002 20.011.003	Mounting Kit 9		5.090.000
Dome Window		20.040.015	Corrugated Tube 28mm		20.000.006	Mounting Kit 10		5.100.000
30/60mm Extension		15.030.030 15.030.085	Deflection Mirror 90°		20.020.004	Mounting Kit 15		5.150.000
Rear Wall E		20.040.014	Dragon Air Nozzle		50.100.030	Mounting Kit 16/16m		5.160.000 5.160.000m
M72 Front Lid		20.040.018	Mounting Tool		90.000.004	Mounting Kit 17/17m		5.170.000 5.170.000m



Benefits:

- For cameras up to 61 x 61mm cross section
- Perfect for underwater use
- IP68 protection class
- Double seal system
- Robust construction
- Flexible camera positioning
- High chemical resistance
- Vibration-proof mounting
- Camera mount included
- Excellent heat dissipation
- Integration of ring lights possible
- Tested 12h in 10m water depth



Technical Details:

Max. Camera Size (w x h)	61 x 61mm	Weight (without camera mount)	Approx. 1400g
Max. Lens Diameter	85mm (in profile) 78mm (in front lid)	Enclosure Material	Anodized Aluminum
Inner Length	172mm	Enclosure Seals (double)	EPDM
Enclosure Dimensions (w x h x l, without cable gland)	96 x 96 x 194mm	Inner Tube Diameter (max. connector size)	15mm
Window Aperture	65mm	Cable Gland Seal	TPE
Standard Window	BK7, double sided ARC		
3" Germanium	Order Number: 20.000.018		
3" Acrylic, double sided AR	Order Number: 20.000.033		
Window Seal	EPDM		
Protection Class	IP66 (Nema 4) IP68 (Nema 6)		



The mount guarantees excellent heat dissipation



3" Front Lid

Profile

RearWall

Protective Tube

Order Number (please specify the camera type for each order!):

Enclosure Description	Rear Wall	Order Number
IP68 enclosure with 3" window, 5m protective tube, front and back lid with double O-ring seals	M32 cable gland for protective tube system	2X.X50.200

Accessories:

Product	Image	Order No.	Product	Image	Order No.	Product	Image	Order No.
Air Nozzle		50.100.025	Cooling Module		60.100.010	Mounting Kit 6		5.060.000
3" Wind Curtain		50.100.011	El. Heating Plate		70.100.018	Mounting Kit 7		5.070.000
Pneumatic Shutter		50.200.021	Sun Roof Size M		20.011.002	Mounting Kit 9		5.090.000
Deflection Mirror 90°		20.020.004	Mounting Tool		90.000.004	Mounting Kit 10		5.100.000
Position Ring		20.040.002	Mounting Kit 1		5.010.000	Mounting Kit 15		5.150.000
Protective Tube (1m)		20.000.005	Mounting Kit 2		5.020.000	Mounting Kit 16/16m		5.160.000 5.160.000
Dragon Air Nozzle		50.100.030				Mounting Kit 17/17m		5.170.000 5.170.000m



Benefits:

- For cameras with 62 x 62mm cross section and larger depending on edge radius as Dalsa Linea, Basler Runner, Flir A400-700/GF77a, Jai Spark etc.
- Special lid with Germanium and optical window for Flir A400-700 available
- Reverse version allows the use of all Orca front lids
- High IP protection class and chemical resistance
- Flexible camera positioning, vibration-proof mounting
- Excellent heat dissipation



Technical Details:

Max. camera size (w x h)	62 x 62mm (depending on edge radius also bigger)	Weight (without camera mount)	Approx. 1350g
Max. lens diameter	87mm 85mm (reverse)	Enclosure Material	Anodized Aluminum
Inner length Clamping area	212mm (200mm reverse) 160mm	Window/Enclosure Seals	EPDM
Enclosure Dimensions (w x h x l, without cable gland)	96 x 96 x 227mm (214mm reverse) Front lid: d=100mm	Cable Gland Aperture (max. connector size)	22mm (Rear Wall A) 26.5mm (Rear Wall C)
Window aperture	68mm (standard) 65mm (reverse)	Cable Diameter	Self Drilling (Rear Wall C)
Standard Window	BK7, double sided AR	Cable Gland Seal	TPE
3" IR Mirror	Order Number: 20.000.064	Protection class	IP66 (Nema 4) IP67 (Nema 6)
3" Germanium	Order Number: 20.000.018		
Ge/BK7 Twin-Window	Order Number: 20.000.098		
3" Acrylic, double sided AR	Order Number: 20.000.033		



Megalodon Standard and Reverse backside view



The mount guarantees excellent heat dissipation



Megalodon Standard

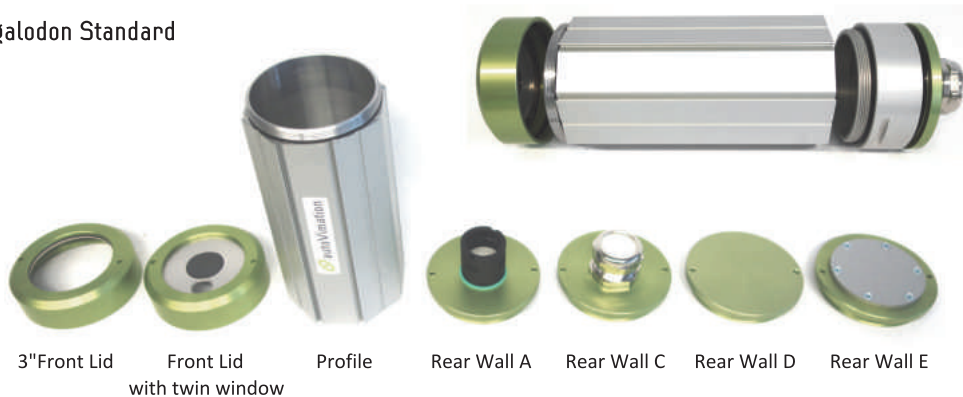

Order Numbers (please specify the camera type for each order!):

Rear Wall Type	Order Number	Special Accessory	Order Number
A	2X.X95.200	Surcharge Twin-Window for Flir A400-700/GF77a	20.000.098
C	2X.X96.200		
D	2X.X99.200	Surcharge Rear Wall E	20.040.014

Megalodon Reverse



Order Numbers (please specify the camera type for each order!):

Rear Wall Type	Order Number	Special Accessory	Order Number
A	2X.X90.200	Surcharge Dome Window	20.040.015
C	2X.X91.200	Surcharge M72 Lid	20.040.018

You can use almost any Orca accessories for the Megalodon Reverse incl. Wind Curtain and Meganova Ringlight!



Benefits:

- For cameras up to 75 x 75mm cross section
- Special lid for IFM/Lucid TOF cameras available
- With flange all Orca lids and extensions usable
- High IP rating and high chemical resistance
- Vibration-proof mounting
- Compact size, small deadweight
- Flexible camera positioning
- Excellent heat dissipation
- Dome window option
- T-Slot & dovetail profile usable for installation
- Integration of Meganova ring lights possible



Technical Details:

Max. Camera Size (w x h)	75 x 75mm
Max. Lens Diameter	78mm
Inner Length (Size) Standard With Flange	(S) (M) (L) 134, 184, 254mm 144, 194, 264mm
Cross Section (w x h)	100 x 100mm
Length (Size) without cable gland Standard With Flange	(S) (M) (L) 150, 200, 270mm 162, 212, 282mm
Window Aperture	65mm
3" Standard Window	BK7, double-sided ARC
3" IR Mirror	Order Number: 20.000.064
3" Germanium	Order Number: 20.000.018
3" Acrylic, no coating	Order Number: 20.000.003
3" Acrylic, double-sided AR	Order Number: 20.000.033
Protection Class	IP66 (Nema 4)

Weight (Size) Standard With Flange	(S) (M) (L) ~930g , 1090g, 1315g ~1045g, 1205g, 1430g
Enclosure Material	Anodized Aluminum
Window/Enclosure Seals	EPDM
Cable Gland Aperture (max. connector size)	22mm (Rear Wall A) 26.5mm (Rear Wall C)
Cable Diameter	Self drilling (Rear Wall C)
Cable Gland Seal	TPE (Rear Wall C)



The mount guarantees excellent heat dissipation



3" Front Lid 3" Flange Profile S Profile M Profile L Rear Wall A Rear Wall C Rear Wall D

Order Numbers (please specify camera type!):

Produkt ID	Camera Type	Enclosure ID	3" Window	Rear Wall Type	3" Flange	Length
2	X.X Please specify camera type!	0	A: 0 C: 1 D: 2		A: 5 C: 6 D: 7	S: 130 M: 180 L: 250
IFM O3D TOF	Rear Wall C	2X.X08.151	Lucid Helios2 TOF	Rear Wall C	2X.X08.152	

Example: 2X.X06.250 | Stingray L | 3" flange | rear wall C

Accessories:

Product	Image	Order No.	Product	Image	Order No.	Product	Image	Order No.
Dragon Air Nozzle		50.100.030	Cooling Module		60.100.010	Mounting Kit 2		5.020.000
3" Wind Curtain		50.100.011	El. Heating Plate		70.100.018	Mounting Kit 6		5.060.000
Tube 3" wind curtain		50.100.018	Sun Roof Size S		20.011.001	Mounting Kit 7		5.070.000
Shutter 3"		50.200.021 +6.041.145	Size M		20.011.002	Mounting Kit 9		5.090.000
			Size L		20.011.003			
30/60mm Extension		15.030.030 15.030.085 (Flange)	Mounting Tool		90.000.004	Mounting Kit 10		5.100.000
Meganova Ring Light		See Data Sheet	Corrugated Tube 28mm		20.000.006	Mounting Kit 15		5.150.000
Dome Window		20.040.015 (Flange)	Slot Nut 13x13mm		40.037	Mounting Kit 16/16m		5.160.000 5.160.000m
M72 Front Lid		20.040.018 (Flange)	Mounting Kit 1		5.010.000	Mounting Kit 17/17m		5.170.000 5.170.000m



Benefits:

- For cameras up to 90 x 150mm cross section
- Robust construction
- High IP protection class
- Flexible camera positioning
- High chemical resistance
- Vibration-proof mounting
- Camera mount included
- Excellent heat dissipation
- Integration of ring lights possible
- Dome window option



Technical Details:

Max. Camera Size (w x h)	90 x 150mm
Max. Lens Diameter	90mm (in profile) 78mm (in front lid)
Inner Length	189mm (Size M) 259mm (Size L) 309mm (Size XL)
Enclosure Dimensions (w x h x l, without cable gland)	173 x 113 x 207mm (M) 173 x 113 x 277mm (L) 173 x 113 x 327mm (XL)

Window Aperture	45mm (2" window) 65mm (3" window)
Standard Window	BK7, double sided ARC
2" IR Mirror	Order Number: 20.000.010
3" IR Mirror	Order Number: 20.000.064
2" Sapphire	Order Number: 20.000.016
2" Germanium	Order Number: 20.000.017
3" Germanium	Order Number: 20.000.018
2" Acrylic, uncoated	Order Number: 20.000.058
2" Acrylic, double sided AR	Order Number: 20.000.029
3" Acrylic, double sided AR	Order Number: 20.000.033
Window Seal	EPDM

Protection Class	IP65
-------------------------	------

Weight (without cable gland)	Approx. 2300g (Size M) Approx. 2650g (Size L) Approx. 2900g (Size XL)
Enclosure Material	Powder Coated Aluminum
Enclosure Seals	NBR

Cable Gland Aperture (max. connector size)	22mm (Rear Wall A) 26.5mm (Rear Wall C)
Cable Diameter	Self drilling (Rear Wall C)
Cable Gland Seal	TPE



The mount provides good heat dissipation

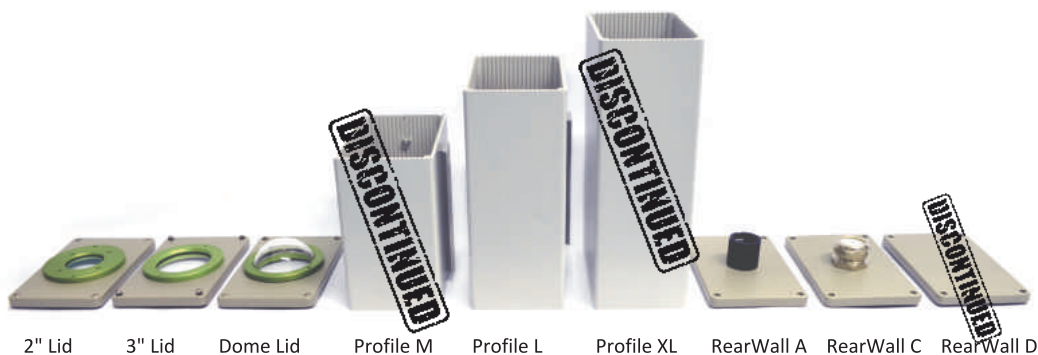

Order Numbers (please specify the camera type for each order!):

Enclosure Size	Rear Wall	Order Number	Enclosure Size	Rear Wall	Order Number
L, 3" Window	A	2X.X65.250	L, 3" Germanium Window, for e.g. Flir A600	C	2X.X68.250
	C	2X.X66.250			

Accessories:

Product	Image	Order No.	Product	Image	Order No.	Product	Image	Order No.
2" Wind Curtain		50.100.010	Cooling Module		60.100.020	Mounting Kit 7		5.070.000
Tube Wind Curtain 2"		50.100.017	Corrugated Tube 28mm		20.000.006	Mounting Kit 9		5.090.000
3" Wind Curtain		50.100.011	Mounting Kit 1		5.010.000	Mounting Kit 10		5.100.000
Dome Window		20.040.015	Mounting Kit 2		5.020.000	Mounting Kit 15		5.150.000
30mm Extension		15.030.030	Mounting Kit 6		5.060.000	Mounting Kit 16/16m		5.160.000 5.160.000
60mm Extension		15.030.085	M72 Front Lid		20.040.018	Mounting Kit 17/17m		5.170.000 5.170.000m
						Mounting Tool		90.000.004



Vorteile:

- Für Kameras bis zu 100 x 100mm Querschnitt
- 3" oder 4" Fenster für große Objektive
- Integrierte Wasserkühlkanäle optional
- Vibrationssichere Montage
- Flexible Kamerapositionierung
- Sehr gute Wärmeableitung
- Mit Flansch:
 - Für Meganova Ringlicht geeignet
 - alle Orca-Deckel und Verlängerungen nutzbar
- Hohe IP Schutzklasse und chemische Beständigkeit

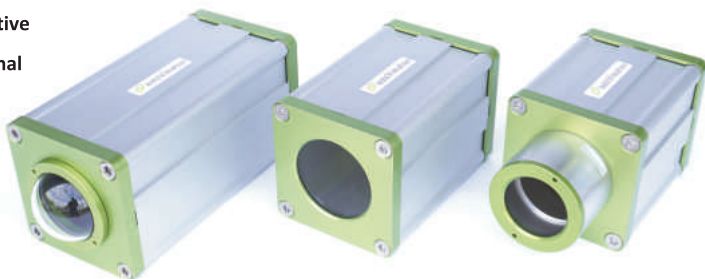

Technical Details:

Max. Camera Size (w x h)	100 x 100mm
Max. Lens Diameter	120mm
Inner Length (Size)	(S) (M) (L) 156, 196, 266mm
Cross Section (w x h)	100 x 100mm
Length (Size) without cable gland	(S) (M) (L) 172, 212, 282mm
Standard With Flange	179, 219, 289mm
Window Aperture 3"/4"	65mm/88mm
4" Standard Window	BK7, double-sided ARC
3" Standard Window	BK7, double-sided ARC
3" IR Mirror	Order Number: 20.000.064
3" Germanium	Order Number: 20.000.018
3" Acrylic, no coating	Order Number: 20.000.003
3" Acrylic, double-sided AR	Order Number: 20.000.033
Protection Class	IP66 (Nema 4) IP67 (Nema 6)

Weight (Size)	(S) (M) (L)
	Standard ~2.3Kg ~2.7Kg ~3.3Kg
With Flange	~2.4Kg ~2.8Kg ~3.4Kg
Enclosure Material	Anodized Aluminum
Window/Enclosure Seals	EPDM
Cable Gland Aperture (max. connector size)	22mm (Rear Wall A) 26.5mm (Rear Wall C)
Cable Diameter	Self drilling (Rear Wall C)
Cable Gland Seal	TPE (Rear Wall C)



The mount guarantees excellent heat dissipation



4"Front Lid 3" Flange Profile S Profile M Profile L Rear Wall A Rear Wall C Rear Wall D

Order Numbers (please specify camera type!):

Produkt ID	Camera Type	Enclosure ID	4" Window	Rear Wall	3" Flange	Length
2	X.X Please specify camera type!	2	A: 0 C: 1 D: 2		A: 5 C: 6 D: 7	S: 140 M: 180 L: 250
Produkt ID	Camera Type	Enclosure ID	3" Window	Rear Wall	3" Flange	Length
2	X.X Please specify camera type!	2	A: 0 C: 1 D: 2	with cooling option	A: 5 C: 6 D: 7	S: 141 M: 181 L: 251

Accessories:

Product	Image	Order No.	Product	Image	Order No..	Product	Image	Order No..
Dragon Air Nozzle		50.100.030	El. Heating Plate		70.100.018	Mounting Kit 6		5.060.000
3" Wind Curtain		50.100.011 For lange	Mounting Tool		90.000.004	Mounting Kit 7		5.070.000
Tube 3" wind curtain		50.100.018	Corrugated Tube 28mm		20.000.006	Mounting Kit 9		5.090.000
30/60mm Extension		15.030.030 15.030.085 For Flange	Meganova Ring Light		See Data Sheet	Mounting Kit 10		5.100.000
Pneumatic Shutter		50.200.030	Mounting Kit 1		5.010.000	Mounting Kit 15		5.150.000
Dome Window		20.040.015 For Flange	Mounting Kit 2		5.020.000	Mounting Kit 16/16m		5.160.000 5.160.000m
M72 Front Lid		20.040.018 For Flange						



Benefits:

- Perfect for cameras with 90° viewing direction
- Robust construction
- Compact design
- High IP protection class
- High chemical resistance
- Vibration-proof mounting
- Camera mount included
- Good heat dissipation
- Special lid with twin window for Flir Ax8



Technical Details:

Inner Width	68mm
Inner Length	150mm
Max. Camera Height [incl. lens]	36mm [42mm] (S) 36mm [72mm] (ST)
Enclosure Dimensions (w x h x l, no cable gland)	175 x 80 x 62mm (S) 175 x 80 x 92mm (ST)
Window Aperture	42mm (2" window) 28/17mm (Ge/BK7, Ax8)
Standard Window	BK7, double sided ARC
2" IR Mirror	Order Number: 20.000.010
2" Sapphire	Order Number: 20.000.016
2" Germanium	Order Number: 20.000.017
2" Acrylic, uncoated	Order Number: 20.000.058
2" Acrylic, double sided AR	Order Number: 20.000.029
Window Seal	FKM Hytrek (Ax8)
Protection Class	IP66 (Nema 4) IP67 (Nema 6)

Weight	Approx. 710g (S) Approx. 880g (ST)
Enclosure Material	Powder Coated Aluminum
Enclosure Seals	Polyurethane
Cable Gland Aperture (max. connector size)	20mm
Cable Diameter	Self drilling
Cable Gland Seal	TPE



The mount provides good heat dissipation



Different lid versions are available, also with Double Window Germanium/Glas for the Flir Ax8

Order Numbers (please specify the camera type for each order!):

Chameleon S	20.100.062	Chameleon ST	20.100.092
Chamäleon S Ax8	20.100.094		



The double window enables the use of IR and optical camera at the same time



Ax8 enclosure with air nozzle

Accessories:

Product	Image	Order No.	Product	Image	Order No.	Product	Image	Order No.
2" Wind-curtain		50.100.010	Mounting Kit 1		5.010.000	Mounting Kit 9		5.090.000
Tube Wind Curtain 2"		50.100.017	Mounting Kit 2		5.020.000	Mounting Kit 10		5.100.000
Mounting Plate S		20.105.997	Mounting Kit 6		5.060.000	Mounting Kit 15		5.150.000
Air Nozzle		50.100.025	Mounting Kit 7		5.070.000	Mounting Kit 16/16m		5.160.000 5.160.000m
Dragon Air Nozzle		50.100.030				Mounting Kit 17/17m		5.170.000 5.170.000m



Benefits:

- Robust construction
- High IP protection class
- High chemical resistance
- Vibration-proof mounting
- Camera mount included
- Perfect for cameras with 90° viewing direction
- Integration of ring lights possible
- Dome window option



Technical Details:

Inner Width	111mm
Inner Length	204mm
Max. Camera Height (incl. lens, +30mm or +60mm with extension)	48mm (L65) 58mm (L75) 63mm (L80) 73mm (L90)
Enclosure Dimensions (w x h x l, without cable gland)	220 x 120 x 65mm (L65) 220 x 120 x 75mm (L75) 220 x 120 x 80mm (L80) 220 x 120 x 90mm (L90)

Weight	Approx. 1500g (L65) Approx. 1600g (L75) Approx. 1700g (L80) Approx. 1800g (L90)
Enclosure Material	Powder Coated Aluminum
Enclosure Seals	Polyurethane

Window Aperture	45mm (2" window) 76mm (3" window)
Standard Window	BK7, double sided ARC
2" IR Mirror	Order Number: 20.000.010
3" IR Mirror	Order Number: 20.000.064
2" Sapphire	Order Number: 20.000.016
2" Germanium	Order Number: 20.000.017
3" Germanium	Order Number: 20.000.018
2" Acrylic, uncoated	Order Number: 20.000.058
2" Acrylic, double sided AR	Order Number: 20.000.029
3" Acrylic, double sided AR	Order Number: 20.000.033
Window Seal	EPDM

Cable Gland Aperture (max. connector size)	20mm
Cable Diameter	Self drilling
Cable Gland Seal	TPE

Protection Class	IP66 (Nema 4) IP67 (Nema 6)
-------------------------	--------------------------------



The mount guarantees good heat dissipation



The components can be combined in multiple variations to adapt to the height of the camera/lens combination

Order Numbers (please specify the camera type!):

Chameleon L	
Enclosure Type	Order Number
L65	20.105.065
L75	20.105.075
L80	20.105.080
L90	20.105.090



Accessories:

Product	Image	Order No.	Product	Image	Order No.	Product	Image	Order No.
3" Wind Curtain		50.100.011	Moun. Plate Crosswise		20.105.998 for L only	Mounting Kit 9		5.090.000
Tube Wind Curtain 3"		50.100.018	Moun. Plate Lengthwise		20.105.999 for L only	Mounting Kit 10		5.100.000
Dome Window		20.040.015 for L only	Mounting Kit 1		5.010.000	Mounting Kit 15		5.150.000
30mm Extension		15.030.030 for L only	Mounting Kit 2		5.020.000	Mounting Kit 16/16m		5.160.000 5.160.000m
60mm Extension		15.030.085 for L only	Mounting Kit 6		5.060.000	Mounting Kit 17/17m		5.170.000 5.170.000m
M72 Front Lid		20.040.018 for L only	Mounting Kit 7		5.070.000	Mounting Tool		90.000.004 for L only
Dragon Air Nozzle		50.100.030						



Benefits:

- For D415, D435, D455
- Robust construction
- High IP protection class
- High chemical resistance
- Vibration-proof mounting
- Camera mount included
- Good heat dissipation
- Compact size
- Affordable price
- Adaptable to all Mounting Kits
- USB cable feeds through the cable gland



Technical Details:

Dimensions (w x h x l, without cable gland)	150 x 64 x 34mm
Weight	Approx. 500g

Window Material	BK7
------------------------	-----

Colour	Light grey, RAL 7001 other colours on request
---------------	--

Enclosure Material	Powder Coated Aluminum
---------------------------	------------------------

Enclosure Seals	Polyurethane
------------------------	--------------

Options	- Dovetail profiles - Pressure equalising valve for outdoor use
----------------	---

Protection Class	IP66 (Nema 4) IP67 (Nema 6)
-------------------------	--------------------------------

Cable Gland Aperture (max. connector size)	13.5mm (D415, D435) 16mm (D455)
--	------------------------------------

Cable Diameter	4-6.5mm Self drilling (D455)
-----------------------	---------------------------------

Cable Gland Seal	TPE
-------------------------	-----



The mount guarantees good heat dissipation



The enclosures adapt to all Mounting Kits

Order Numbers:

Chameleon XS			
Enclosure Type	Order Number	Enclosure Type	Order Number
RealSense D415	20.105.390	RealSense D435	20.105.391
Enclosure Type	Order Number	Enclosure Type	Order Number
RealSense D455	20.105.393	RealSense T265	discontinued

Accessories:

Product	Image	Order No.	Product	Image	Order No.	Product	Image	Order No.
30mm Adapter		20.105.993	Mounting Kit 29		5.290.000	Mounting Kit 9		5.090.000
Mounting Kit 21		5.210.000	40mm Adapter		20.105.994	Mounting Kit 10		5.100.000
Mounting Kit 22		5.220.000	Mounting Kit 1		5.010.000	Mounting Kit 15		5.150.000
Mounting Kit 24/24m		5.240.000 5.240.000m	Mounting Kit 2		5.020.000	Mounting Kit 16/16m		5.160.000 5.160.000
Mounting Kit 27		5.270.000	Mounting Kit 6		5.060.000	Mounting Kit 17/17m		5.170.000 5.170.000m
Mounting Kit 28		5.280.000	Mounting Kit 7		5.070.000			



Benefits:

- Robust construction
- High IP protection class
- High chemical resistance
- Vibration-proof mounting
- Camera mount included
- BK7 or acrylic windows available
- Good heat dissipation thanks to heat conductive tape between camera and enclosure
- Easy assembly
- With Orca adapter also for wide angle lenses
- With Peltier cooling and soon in stainless steel available



Technical Details:

Dimensions (l x w x h, without cable gland and dovetail mounting plate)	230 x 200 x 111mm
Weight (without dovetail profiles)	Approx. 3000g

Window Materials	BK7, double sided ARC Acrylic, double sided ARC
Window Aperture	45mm
Window Seal	NBR

Colour	Light grey, RAL 7001
Enclosure Material	Powder Coated Aluminum
Enclosure Seals	Polyurethane

Options	- Dovetail mounting plate - Pressure equalising valve for outdoor use
----------------	---

Protection Class	IP66 (Nema 4) IP67 (Nema 6)
-------------------------	--------------------------------

Cable Gland Aperture (max. connector size)	26.5mm (M32, GigE) 42mm (M50, Camera Link)
--	---

Cable Diameter	Self-drilling
-----------------------	---------------

Cable Gland Seal	TPE
-------------------------	-----



The mount guarantees good heat dissipation



Thanks to the Orca adapter lenses with shorter focal length are also usable



Chamäleon FX with dovetail profiles to use autoVimation Mounting Kits

Order Numbers:

Chameleon FX			
Enclosure Type	Order Number	Accessories	Order Number
FX10, M32 (GigE)	20.105.294	Surcharge 2" Acrylic ARC	20.000.049
FX10, M50 (Camera Link)	20.105.291	Surcharge 2" Acrylic FDA	20.000.032
FX17, M32 (GigE)	20.105.293	Dovetail Mounting Plates	20.105.995
FX17, M50 (Camera Link)	20.105.295		
Keyence VS-L	Please ask!		

Accessories:

Product	Image	Order No.	Product	Image	Order No.	Product	Image	Order No.
2"/3" Wind Curtain		50.100.010	30mm Extension		15.030.030	Mounting Kit 7		5.070.000
		50.100.011						
2"/3" Wind Curtain		50.100.017	60mm Extension		15.030.085	Mounting Kit 9		5.090.000
		50.100.018						
Orca adapter		15.030.002	Mounting tool		90.000.004	Mounting Kit 10		5.100.000
Surcharge 3" front lid		20.040.019	Mounting Kit 1		5.010.000	Mounting Kit 15		5.150.000
Surcharge M72 lid		20.040.018	Mounting Kit 2		5.020.000	Mounting Kit 16/16m		5.160.000 5.160.000m
Surcharge Dome lid		20.040.015	Mounting Kit 6		5.060.000	Mounting Kit 17/17m		5.170.000 5.170.000m



Benefits:

- Peltier cooling up to 30°C temperature difference
- 24V/DC power enables also e.g. supply via solar panels / batteries and so independent operation is possible
- High chemical resistance
- Easy and vibration-proof mounting
- Camera mount included
- High IP protection class



Technical Details FX Enclosure with Peltier Cooling:

Dimensions (l x w x h, without cable gland and tube)	230 x 200 x 180mm
Weight (without dovetail profiles)	~4900g

Ambient Temperature	0 - 70°C
Max. Temp. Difference without camera heat	30°C
Maximum Cooling Power	53,2W at dT=0°C
Input Voltage	24V/DC

Protection Class Enclosure	IP66 (Nema 4) IP67 (Nema 6)
Protection Class Fan	IP54



Chameleon FX with Peltier Cooling and in stainless steel version with IP69K hygienic design

Order Numbers:

Chameleon FX Peltier			
Enclosure Type	Order Number	Accessories	Order Number
FX10 Peltier, M32 (GigE)	20.106.294	Surcharge 2" Acrylic ARC	20.000.049
For FX10/17, M50 (C. Link) For FX17, M32 (GigE) For Keyence VS, M32/M50	Please ask!	Surcharge 2" Acrylic FDA	20.000.032



Benefits:

- IP 69K hygienic design
- Stainless steel enclosure in AISI 316L
- High chemical resistance
- Easy and vibration-proof mounting
- Camera mount included
- Good heat dissipation
- Robust and compact design
- Hygienic assembly with special mounting kit to the machine

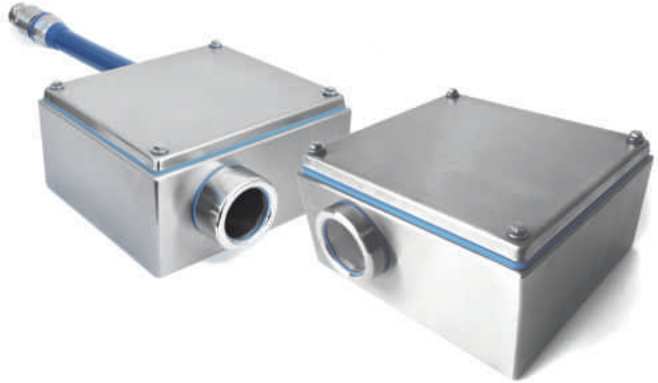

Technical Details:

Dimensions (l x w x h, without cable gland and tube)	220 x 210 x 108mm
Weight (without tube)	Ca. 4500g
Window Material	BK7, double sided ARC
Window Aperture	45mm
Window Seal	EPDM

Protection Class	IP69K
Cable Gland Aperture (max. connector size)	19mm
Cable Gland Seal	TPE
Enclosure Material	Stainless Steel AISI 316L
Enclosure Seals	Silicone

Order Numbers:

Chameleon FX Hygienic IP69K			
Enclosure Type	Order Number	Accessories	Order Number
FX10 (38°, GigE)	20.105.296	Surcharge 2" Acrylic ARC	20.000.049
FX17 (38°, GigE)	20.105.297	Surcharge 2" Acrylic FDA	20.000.032
For Keyence VS	Please ask!	Hygienic Mounting Kit	20.105.298
		26.5x21 PU Tube	80.007.003



Benefits:

- For cylindrical laser with 19 and 20mm diameter
- Robust construction
- Compact size
- Small dead weight
- High IP protection class
- High chemical resistance
- Vibration-proof mounting
- Laser mount included
- Good heat dissipation



Technical Details:

Laser Diameter	19mm 20mm
Inner Length	120mm 150mm 180mm
Enclosure Dimensions (w x h x l, incl. cable gland)	34 x 34 x 150mm 34 x 34 x 180mm 34 x 34 x 210mm
Window Aperture	28mm
Standard Window	BK7, double sided ARC
Saphire	Order Number: 20.000.041
Window Seal	Hytrel
Protection Class	IP66 (Nema 4)

Weight (incl. laser mount)	Approx. 240g Approx. 270g Approx. 300g
Enclosure Material	Anodized Aluminum
Enclosure Seals	EPDM
Cable Gland Aperture (max. connector size)	16mm
Cable Diameter	4-6.5mm
Cable Gland Seal	TPE



The mount guarantees good heat dissipation

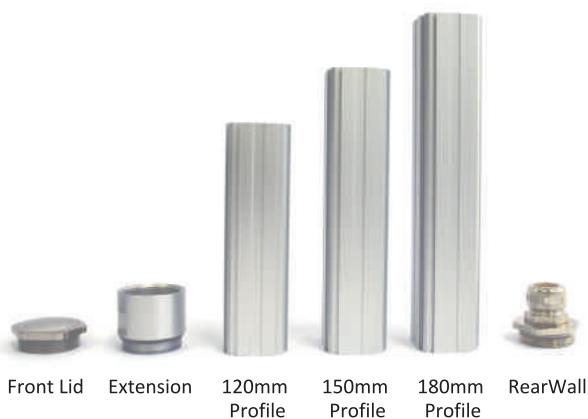







Order Numbers:

Laser Diameter	Inner Length	Order Number
19mm	120mm	40.010.020
	150mm	40.010.030
	180mm	40.010.040

Laser Diameter	Inner Length	Order Number
20mm	120mm	40.010.021
	150mm	40.010.031
	180mm	40.010.041

Accessories:

Product	Image	Order Number
20mm to 30mm Adapter Bracket, to use laser with 30mm profiles		10.049.050
20mm to 40mm Adapter Bracket, to use laser with standard profiles		10.049.051
Vertical Laser Mount, to fix the enclosure vertical to a 40mm profile		40.001.005
Rotary Laser Mount, to fix the enclosure rotary to a 40mm profile		40.001.006
20mm Bracket		10.049.049
28 x 28mm Adapter Plate, for 2x M4 csk screws		40.001.009

Product	Image	Order Number
13mm Adapter, laser and Orca (orthogonal bracket) in the same optical axis		40.001.007
29mm Adapter, laser and Orca (rotary mount) in the same optical axis		40.001.008
25mm Enclosure Extension, enables focussing, while attached in the housing		40.010.025
Surcharge for laser holder in Salamander/Dolphin (order separately) with 19/20/30mm diameter		14.100.019 14.100.020 14.100.030
Cooling Module for Laser Enclosures		60.100.030
Air Nozzle for Laser Enclosures		50.100.020



Benefits:

- Hygienic PLUS IP69k protectiv enclosure
- For cylindric lasers with $\varnothing 19 - 20\text{mm}$ diameter
- Laser mount with good heat dissipation
- Easy window exchange thanks to snap ring mount
- Easy focus adjustment after front lid removal
- All Laser can be mounted close behind the window
- The Piranha enclosure will be shipped with standard V4A cable gland with 16mm bore, as usually the rear end will be mounted inside a hygienic T- Piece
- For other mounting variations the Piranha is also available with hygienic cable gland



Technical Details:

Laser Diameter	19mm 20mm
Inner Length	120mm
Enclosure Dimensions d x l without cable gland	40 x 176.6mm
Weight incl. hygienic cable gland	~650g
Window Aperture	20mm
Standard Window Sapphirre Acrylic	BK7, double sided AR Order Number: 20.000.041 Order Number: 20.000.113
Enclosure Seals	EPDM
Enclosure Material	V4A AISI 316L

Cable Gland Seal	Hygienic: TPU Standard V4A: TPE
Sealing Range of the Hygienic Cable Gland	15-18mm
Inner Diameter Tube/Cable Gland	Hygienic Tube: 13mm V4A Cable Gland: 16mm
Protection Class	IP69K (Hyg. Cable Gland) IP68 (V4A Cable Gland)



The mount provides good heat dissipation



The Hygienic Building Kit enables IP69K protection for cameras, lasers and cables

Order Numbers:

Description	Laser diameter	Order Number
Piranha Laser Enclosure, hygienic design, IP68 cable gland	19mm	40.020.008
Piranha Laser Enclosure, hygienic design, IP68 cable gland	20mm	40.020.009
Piranha Laser Enclosure, hygienic design, IP69K hygienic cable gland	19mm	40.020.010
Piranha Laser Enclosure, hygienic design, IP69K hygienic cable gland	20mm	40.020.011

Accessories:

Product	Image	Order No.	Product	Image	Order No.	Product	Image	Order No.
M25 Gland Hygiene		80.005.003	M32 Gland Hygiene		80.005.004	M40 Gland Hygiene		80.005.005
M25 Adapter		80.005.001	M32 Adapter		80.005.002	M25 Nut		80.005.006
18x13 PUR Tube		80.007.001	M32 Nut		80.005.007	M32 Nut		80.005.007
90° Tube Connector		80.006.002	M40Nut		80.005.008	Hygienic Rear Mount		80.006.000
90° Hygienic Connector		80.006.001	25x19 PUR Tube		80.007.002	Hygienic T-Piece		80.006.007
			Mount Standard		80.006.006			
			Hygienic Mount Foot		80.006.004			

Enclosure Extensions

Benefits:

- Enables easier lens access
- Extension of standard enclosure length
- For Salamander and Orca enclosures
- Front or backside assembly possible
- 30mm or 60mm length
- IP protection class is conserved



Technical Details:

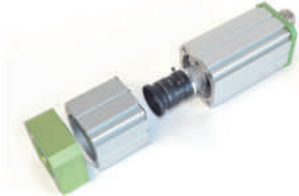

30mm Salamander Extension	
Seal	NBR
Dimensions (w x h x l)	66 x 66 x 30mm d=55mm (inside)
Weight	116g
Order Number	15.015.030

60mm Salamander Extension	
Seal	NBR
Dimensions (w x h x l)	66 x 66 x 60mm d=55mm (inside)
Weight	234g
Order Number	15.015.060

60mm Salamander Side Exit M32	
Seal	NBR
Dimensions (w x h x l)	66 x 95 x 60mm d=55mm (inside)
Weight	346g
Order Number	15.015.061



30mm Extension for Orca, Mammoth and Chameleon	
Seal	EPDM
Dimensions d x l, without thread)	96 x 30mm 78mm (inner diameter)
Weight	158g
Order Number	15.030.030

60mm Extension for Orca, Mammoth and Chameleon	
Seals	EPDM
Dimensions (d x l, without thread)	96 x 60mm 78mm (inner diameter)
Weight	290g
Order Number	15.030.085



Benefits:

- Use of Orca front lid possible for Salamander, Gecko and Chameleon FX enclosures
- Wider range of usable lenses
- Thanks to dome lid Fisheye lenses usable
- Filter option with M72 front lid
- Orca extensions usable

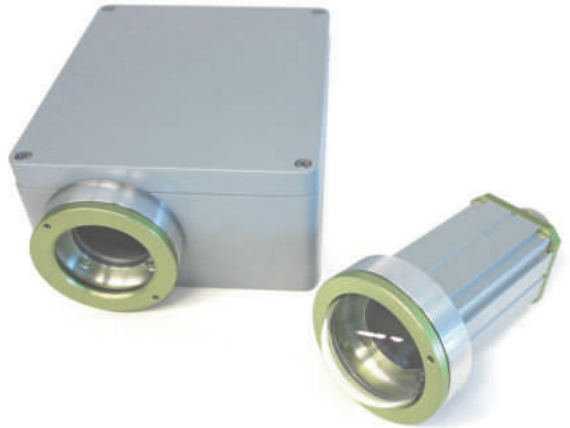

Technical Details:



Salamander-/Orca Adapter	
Seal	NBR
Dimensions (d x l)	96 x 22mm
Weight	126g
Order Number	15.030.001

Gecko-/Orca Adapter	
Seal	NBR
Dimensions (d x l)	96 x 19mm
Weight	114g
Order Number	15.030.002

Accessories:

Product	Image	Order No.	Product	Image	Order No.	Product	Image	Order No.
3" Frontdeckel		20.040.003	Dome-Frontdeckel		20.040.011	M72 Frontdeckel		20.040.017
2" Frontdecke		20.040.004	30mm Verlänger.		15.030.030	60mm Verlänger.		15.030.085

Position Rings and Deflection Mirror

Benefits:

- Precise re-positioning after camera disassembly
- The ring remains inside the enclosure and "remembers" the exact position
- For Salamander, Orca, Nautilus, Dolphin und Shark
- Easy handling



Technical Details:



Position Ring for Feuer-/Salamander/Dolphin	
Dimensions (d x l, without screws)	55 x 13mm
Weight	26g
Order Number	20.020.003

Position Ring for Orca/Nautilus/Shark	
Dimensions (d x l, without screws)	85 x 10mm
Weight	38g
Order Number	20.040.002

Benefits:

- Allows image acquisition at limited space
- Suitable for mid and long focal lenses
- Avoids costly prisms
- 4-6λ surface mirror, reflection >90%



Technical Details:



Deflection Mirror	
Reflection (visible light)	>90%
Dimensions (l x w x h)	168 x 56 x 85mm
Weight	458g
Order Number	20.020.004



Benefits:

- Robust and cost-effective camera mount
- Perfect where no overall IP protection is required
- Good heat dissipation
- Flexible mounting options
- Camera mount included



Technical Details:



Salamander Mounting Block	
Profile Material	Anodized Aluminum
Dimensions (w x h x l)	
60mm Block	66 x 66 x 60mm
100mm Block	66 x 66 x 100mm
164mm Block	66 x 66 x 164mm
Weight	
60mm Block	272g
100mm Block	426g
164mm Block (without camera mount)	698g
Order Number	
60mm Block	15.010.060
100mm Block	15.010.100
164mm Block (specify camera type)	15.010.164

Orca Mounting Block	
Profile Material	Anodized Aluminum
Dimensions (w x h x l)	96 x 96 x 80mm
Weight (without camera mount)	384g
Order Number (specify camera type)	15.030.080



Assembly example

Pneumatic Shutter

Benefits:

- Seals the front window completely
- Can be used in combination with a Wind Curtain
- Compact size
- Robust construction
- For Salamander, Gecko, Orca Nautilus, Megalodon, Elephant
- For Chameleon and Stingray with modified mount possible



Technical Details:



	For 2" Windows	For 3" Windows	For 4" Windows
Pneumatic Connector	4mm	4mm	4mm
Max. Pressure	10bar	10bar	10bar
Seals	EPDM	EPDM	EPDM
Operating Temperature	-10° to +60°C	-10° to +60°C	-10° to +60°C
Operating Range	Approx. 85mm	Approx. 110mm	Approx. 130mm
Dimensions (l x w x h, flap open)	240 x 74 x 64mm	267 x 96 x 64mm	287 x 96 x 64mm
Weight	285g	330g	395g
Order Number	50.200.010	50.200.021 + 6.041.145 for Stingray	50.200.030



Benefits:

- Extends cleaning intervals
- Minimizes dust or light mist on the front window
- Higher efficiency with additional tube
- Combinable with Pneumatic Shutter
- Easy handling

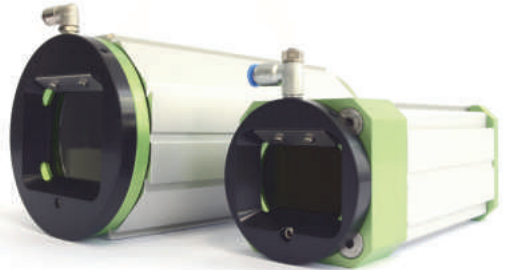

Technical Details:



Wind Curtain for 2" windows (old)	
Connector	4mm
Max. Pressure	10bar
Air Consumption	~160l/min@6bar
Operating Temp.	-10° to +60°C
Dimensions (l x w x h)	86 x 66 x 10mm
Weight	75g
Order Number	50.100.009
Order No. Tubus Holder Bracket	50.100.015 50.100.016 10.040.201

Wind Curtain for 2" windows	
Connector	4mm
Max. Pressure	10bar
Air Consumption	~160l/min@6bar
Operating Temp.	-10° to +60°C
Dimensions (l x w x h)	85 x 65 x 13mm
Weight	65g
Order Number	50.100.010
Order Number Tube 70x50	50.100.017

Wind Curtain for 3" windows	
Connector	4mm
Max. Pressure	10bar
Air Consumption	~250l/min@5bar
Operating Temp.	0 to +120°C
Dimensions (l x w x h)	110 x 95 x 13mm
Weight	115g
Order Number	50.100.011
Order Number Tube 100x50	50.100.018



Benefits:

- Extends cleaning intervals
- High blowing force of 3,3N @ 5Bar
- Wide air stream at short distance
- Low air consumption and noise level
- Combinable with Meganova ringlight



Pneumatic Connector	6mm
Max. Pressure	10Bar
Air Consumption	333l/min
Blowing Force	3.3N @ 5Bar
Noise Level (dB(A))	82
Dimensions (l x w x h)	~85 x 56 x 50mm
Weight	155g

Blowing Distance (mm)	Air Stream Width (mm)
50	63
100	82
200	120
300	160
400	200
500	240
Operating Temperature	0° to + 70°C
Order Number	50.100.030

Air Nozzle

Benefits:

- Extends cleaning intervals
- Minimizes dust or light mist on the front window
- Easy handling



Air Nozzle for 20mm profile (Laser)	
Connector	4mm
Max. pressure	10bar
Air consumption	~160l/min@6bar
Operating Temp.	-10° to +60°C
Dimensions (l x w x h)	90 x 28 x 35mm
Weight	50g
Order Number	50.100.020

Air Nozzle for 30mm profile (Colibri)	
Connector	4mm
Max. pressure	10bar
Air consumption	~160l/min@6bar
Operating Temp.	-10° to +60°C
Dimensions (l x w x h)	115 x 44 x 36mm
Weight	80g
Order Number	50.100.023

Air Nozzle for 40mm profile	
Connector	4mm
Max. pressure	10bar
Air consumption	~160l/min@6bar
Operating Temp.	-10° to +60°C
Dimensions (l x w x h)	115 x 64 x 40mm
Weight	140g
Order Number	50.100.025



Benefits:

- Extends the temperature range for the use of cameras up to -50°C to $+200^{\circ}\text{C}$
- Automatic cooling and heating therefore perfect for the use in climate chambers
- High efficiency
- Cooling or heating of up to five enclosures with one single Cooling Unit
- Manifold safety features
- No cooling liquid is pumped through the enclosure (exception: Mammoth cooling module)
- Easy handling

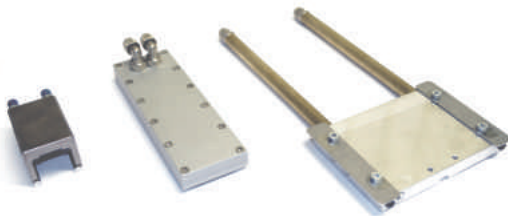
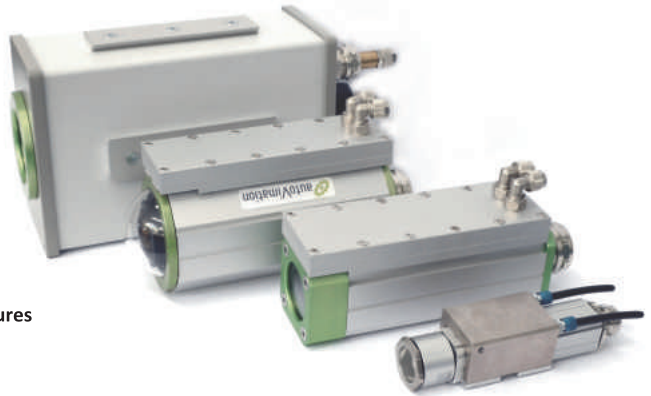

Camera and Laser temperature with water cooling

all values valid for our testing conditions only!

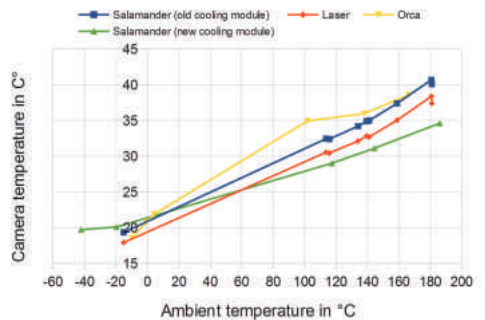

Technical Details:

Laser Cooling Module		Standard Cooling Module		Mammoth Cooling Module	
Tube Connectors	4mm	Tube Connectors	1/4" (~8mm)	Tube Connectors	1/4" (~8mm)
Filling Capacity	Approx. 10ml	Filling Capacity	Approx. 40ml	Filling Capacity	Approx. 40ml
Dimensions (l x w x h)	90 x 28 x 35mm	Dimensions (l x w x h)	195 x 64 x 50mm min. enclosure M	Dimensions (l x w x h)	321x 160 x 16mm
Weight	Approx. 150g	Weight	Approx. 650g	Weight	Approx. 1250g
Order Number	60.100.030	Order Number	60.100.010	Order Number	60.100.020

Water Cooling System

Included in the system:

- Water Cooling Unit
- 250ml cooling concentrate
- 6m Polyurethane tube
- 3m high temp. thermometer cable incl. sensor
- DC power cable

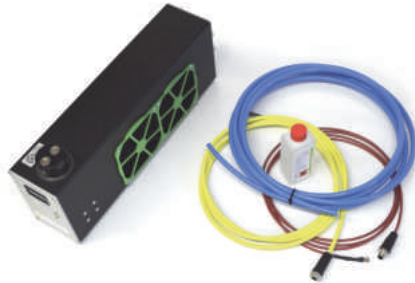

Water Cooling Unit	High Power
Tube Connectors	1/4" (~8mm)
Volume Flow	3l/min
Max. Camera Distance	20m
Max. Pumping Height	2.5m
Input Voltage	12V/DC
Filling Capacity	Approx. 400ml
Max. Power Consumption	Approx. 25W
Max. Switching Power	Approx. 5W
Safety Features (incl. alarm function)	Constant monitoring of: - Camera temperature, flow and fan
Dimensions (l x w x h)	456 x 105 x 203mm
Weight	Approx. 5.40kg
Order Number	60.101.520
Leveling Feet for Cooling Unit Order Number	60.101.521

Accessories:

Produkt	Abbildung	Bestellnr.	Produkt	Abbildung	Bestellnr.	Produkt	Abbildung	Bestellnr.
8x1mm PU-Schlauch		60.101.478	Verbindung 2x 8mm		60.100.501	250ml Kühlkonzentrat		60.101.333
8x1 Teflon Schlauch		60.101.477	Quick Coupling		60.101.480	Sensorkabel Verlänger.		60.100.500
4x1mm PE Schlauch		60.101.476	Überdruckventil		60.101.479	Netzteil 12V/DC		60.101.422
Abzweigung 8 auf 4mm		60.101.479						

Benefits:

- Controlled heating, no overheating possible
- High IP rating
- Numerous plates with one controller possible
- Easy handling
- Usable in combination with the sun roof

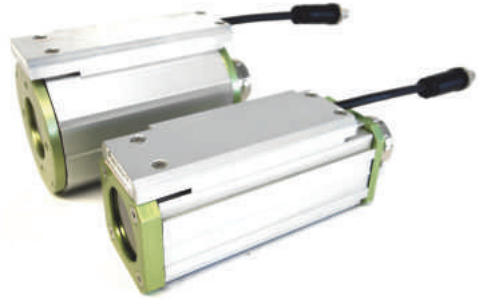

Product	Image	Order Number
Controlled heating plate for Orca/Gecko/Salamander from size S, IP65, incl. controller, temperature sensor and 5m cable, heats to max. 20°C, 75W, 24V/DC		70.100.018
Set of two heating plates for Orca/Gecko/Salamander from size S, IP65, with one controller and temperature sensor, heats to max. 20°C, 2x75W, 24V/DC		70.100.019

Sun Roof

Benefits:

- Highly reflective stainless steel
- Insulated to enclosure
- Easy assembly
- Adjustable position
- Usable in combination with electric heating plate

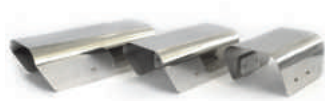

	Sun roof for Salamander and Gecko			Sun roof for Orca		
Size	S	M	L	S	M	L
Length	192mm	245mm	275mm	187mm	237mm	307mm
W x H	108 x 78mm	108 x 78mm	108 x 78mm	140 x 90mm	140 x 90mm	140 x 90mm
Weight	400g	480g	550g	490g	600g	770g
Order Number	20.010.001	20.010.002	20.010.003	20.011.001	20.011.002	20.011.003



Benefits:

- For operation in up to 70°C without sun
- For up to 50°C ambient temperature with strong sun radiation 350W/m²
- Permanent temperature control
- Good UV and ageing resistance
- IP65 (camera enclosure)/IP54 (fan)
- 3" or 4" BK window for large lenses
- Other window materials available
- All Orca extensions and front lids incl. dome window usable
- With Orca extension with Meganova usable
- Only DC voltage required, easy handling
- Fully automatic operation, heating or cooling (depending on version)



Technical Details:

Max. Camera Size (w x h)	100 x 100mm	Enclosure Material	Anodized Aluminium
Max. Lens Diameter	120mm (profile) 78mm (3" front lid and Orca extensions)	Enclosure Seals	EPDM
Inner Length	180mm (M) 250mm (L)	Cable Gland Aperture (max. connector size)	26.5mm
Dimensions (l x w x h) (without cable gland)	212 x 138 x 202 (M)	Cable Diameter	Self drilling
With flange (l x w x h) (without cable gland)	219 x 138 x 202 (M) 289 x 138 x 202 (L)	Cable Gland Seal	TPE
Weight (without camera mount)	Ca. 4.5Kg (M) Ca. 6.1Kg (L)	Operating Voltage	24V/DC
Window Aperture	88mm (4") 65mm (3")	Temperature Range (Ambient)	-20 bis +70°C
3"/4" standard window	BK7, double sided AR	Cooling Power	41W at dT=0°C
3" IR Mirror	Order Number: 20.000.064	Protection Class	
3" Germanium	Order Number: 20.000.018	Fan Enclosure	IP54
3" Acrylic, double sided AR	Order Number: 20.000.033	Camera Enclosure	IP65
Window Seal	EPDM		



Order Number (please specify camera type!):

Produkt	Bestellnummer
Turtle MiC Elefant , for cameras up to 100x100mm cross section, inner length 180mm, internal Peltier controller (heating or cooling only), 5m power cable, BK7 4" window, rear wall C	70.600.180
Turtle M Elefant , for cameras up to 100x100mm cross section, inner length 180mm, without Peltier controller, 5m power cable, BK7 4" window, rear wall C	70.700.180
Turtle MiC Elefant Flange , for cameras up to 100x100mm cross section, inner length 180mm, internal Peltier controller (heating or cooling only), 5m power cable, BK7 3" window, rear wall C	70.650.180
Turtle M Elefant Flange , for cameras up to 100x100mm cross section, inner length 180mm, without Peltier controller, 5m power cable, BK7 3" window, rear wall C	70.750.180
Turtle LiC Elefant , for cameras up to 100x100mm cross section, inner length 250mm, internal Peltier controller (heating or cooling only), 5m power cable, BK7 4" window, rear wall C	70.600.250
Turtle L Elefant , for cameras up to 100x100mm cross section, inner length 250mm, without Peltier controller, 5m power cable, BK7 4" window, rear wall C	70.700.250
Turtle LiC Elefant Flange , for cameras up to 100x100mm cross section, inner length 250mm, internal Peltier controller (heating or cooling only), 5m power cable, BK7 3" window, rear wall C	70.650.250
Turtle L Elefant Flange , for cameras up to 100x100mm cross section, inner length 250mm, without Peltier controller, 5m power cable, BK7 3" window, rear wall C	70.750.250
External Peltier Controller , Din rail mount, 16A max current, programmable heating- and cooling levels, temperature control with emergency shut down, max. ambient temperature 60°C	70.300.270
Power supply for Turtle enclosures 24V/DC, 150W, Din rail mount.	70.200.253

Accessories:

Product	Image	Order No.	Product	Image	Order No.	Product	Image	Order No.
Dragon Air Nozzle		50.100.030	Mounting Kit 1		5.010.000	Mounting Kit 10		5.100.000
3" Wind Curtain		50.100.011	Mounting Kit 2		5.020.000	Mounting Kit 15		5.150.000
30/60mm Extension		15.030.030 15.030.085	Mounting Kit 6		5.060.000	Mounting Kit 16/16m		5.160.000 5.160.000m
Dome Window		20.040.015	Mounting Kit 7		5.070.000	Mounting Kit 17/17m		5.170.000 5.170.000m
M72 Front Lid		20.040.018	Mounting Kit 9		5.090.000	Monting Tool		90.000.004

Mounting Kits

Benefits:

- Easy assembly and 90° image rotation
- Flexible adjustment of working distance and orientation
- Robust construction out of anodized aluminum
- Vibration proof
- Resist displacement forces of up to 2000N
- Adapts to any standard T-slot profile

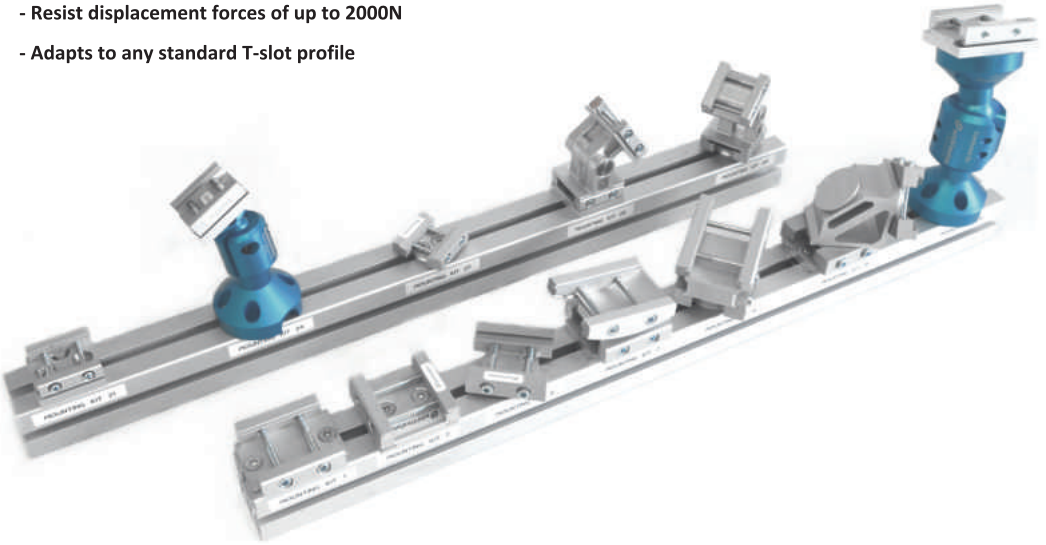

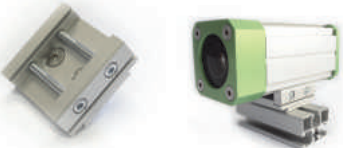
Product	Images	Order Number
Mounting Kit 1 - Parallel mounting pattern - 90° image rotation - Working distance adjustment		5.010.000
Mounting Kit 2 - Vertical mounting pattern - 90° image rotation - Working distance adjustment		5.020.000



Product	Image	Order Number
Mounting Kit 6 <ul style="list-style-type: none">- 360° pan- 90° image rotation- Working distance adjustment		5.060.000
Mounting Kit 7 <ul style="list-style-type: none">- +/- 8° tilt- 90° image rotation- Working distance adjustment		5.070.000
Mounting Kit 9 <ul style="list-style-type: none">- 360° pan- +/- 8° tilt- 90° image rotation- Working distance adjustment		5.090.000
Mounting Kit 10 <ul style="list-style-type: none">- Tripod adapter with 1/4" and 3/8" thread- 90° image rotation- Working distance adjustment		5.100.000
Mounting Kit 15 <ul style="list-style-type: none">- 360° pan- 360° tilt- 90° image rotation- Working distance adjustment		5.150.000







Mounting Kits

Product	Image	Order Number
Mounting Kit 16/16m (metric grey) - 360° pan - >120° tilt - 90° image rotation - Working distance adjustment		5.160.000 5.160.000m
Mounting Kit 17/17m (metric grey) - 360° pan - >120° tilt - 90° image rotation - Working distance adjustment - Adapts to 40mm dovetail profile		5.170.000 5.170.000m
Mounting Kit 18/18m (metric grey) - 360° pan - >30° tilt - 90° image rotation - Working distance adjustment		5.180.000 5.180.000m
Mounting Kit 19/19m (metric grey) - 360° pan - >30° tilt - 90° image rotation - Working distance adjustment - Adapts to 40mm dovetail profile		5.190.000 5.190.000m
Clamp Handle for Knuckle - Tool-free adjustment - Perfect for laboratory use		AFSB-clamp handle SLM-clamp handle (metric)
V2A Cylinder Head Screw UNC 10-24 3/4" - for Mounting Kit 16, 17, 18, 19, 24, 26 - Recommended for outdoor use or corrosive ambient conditions		40.043

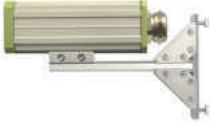

Product	Image	Order Number
Mounting Kit 21 - Parallel and vertical mounting pattern - 90° image rotation - Working distance adjustment - For Colibri enclosures		5.210.000
Mounting Kit 22 - Tripod adapter with 1/4" and 3/8" thread - 90° image rotation - Working distance adjustment - For Colibri enclosures		5.220.000
Mounting Kit 24/24m (metric grey) - 360° endless pan - >35° tilt - 90° image rotation - Working distance adjustment - For Colibri enclosures		5.240.000 5.240.000m
Mounting Kit 26 - 360° endless pan - >35° tilt - 90° image rotation - Working distance adjustment - For Colibri enclosures		5.260.000 5.260.000m
Mounting Kit 27 - 360° endless pan - 90° image rotation - Working distance adjustment - For Colibri enclosures		5.270.000
Mounting Kit 28 - +/- 90° tilt - 90° image rotation - Working distance adjustment - For Colibri enclosures		5.280.000
Mounting Kit 29 - 360° endless pan - +/- 90° tilt - 90° image rotation - Working distance adjustment - For Colibri enclosures		5.290.000

Wall Mounts

Product	Components	Image	Order Number
Wall Mount 101 (without enclosure) - Parallel mounting - 90° image rotation - Working distance adjustment	1x 6.041.144 2x 10.059.296 1x 1.020.XXX (length in mm) 1x 10.040.201		7.101.XXX Arm length (mm)
Wall Mount 102 (without enclosure) - Vertical mounting - 90° image rotation - Working distance adjustment	1x 6.041.144 2x 10.059.296 1x 1.020.XXX (length in mm) 1x 10.044.984		7.102.XXX Arm length (mm)
Wall Mount 106 (without enclosure) - 360° endless pan - 90° image rotation - Working distance adjustment	1x 6.041.144 2x 10.059.296 1x 1.020.XXX (length in mm) 1x 10.040.860		7.106.XXX Arm length (mm)
Wall Mount 107 (without enclosure) - +/- 8° tilt - 90° image rotation - Working distance adjustment	1x 6.041.144 2x 10.059.296 1x 1.020.XXX (Länge in mm) 1x 10.054.638 1x 10.040.201		7.107.XXX Arm length (mm)
Wall Mount 109 (without enclosure) - 360° endless pan - +/- 8° tilt - 90° image rotation - Working distance adjustment	1x 6.041.144 2x 10.059.296 1x 1.020.XXX (length in mm) 1x 10.054.638 1x 10.040.860		7.109.XXX Arm length (mm)
Wall Mount 115 (without enclosure) - 360° endless pan - 360° endless tilt - 90° image rotation - Working distance adjustment	1x 6.041.144 2x 10.059.296 1x 1.020.XXX (length in mm) 2x 10.040.202 1x 10.045.852		7.115.XXX Arm length (mm)
Wall Mount 117 (without enclosure) - 360° endless pan - >120° tilt - 90° image rotation - Working distance adjustment	1x 6.041.144 2x 10.059.296 1x 1.020.XXX (length in mm) 1x 5.170.000		7.117.XXX Arm length (mm)



Product	Components	Image	Order Number
Wall Mount 121 (without enclosure) - Parallel mounting - 90° image rotation - Working distance adjustment - For Colibri enclosures	1x 6.041.144 2x 10.059.296 1x 1.020.XXX (length in mm) 1x 10.062.979		7.121.XXX Arm length (mm)
Wall Mount 122 (without enclosure) - Vertical mounting - 90° image rotation - Working distance adjustment - For Colibri enclosures	1x 6.041.144 2x 10.059.296 1x 1.020.XXX (length in mm) 1x 10.062.979 1x 6.036.199 1x 10.062.830		7.122.XXX Arm length (mm)
Wall Mount 126 (without enclosure) - 360° endless pan - >30° tilt - 90° image rotation - Working distance adjustment - For Colibri enclosures	1x 6.041.144 2x 10.059.296 1x 1.020.XXX (length in mm) 1x 5.260.000		7.126.XXX Arm length (mm)
Wall Mount 127 (without enclosure) - 360° endless pan - 90° image rotation - Working distance adjustment - For Colibri enclosures	1x 6.041.144 2x 10.059.296 1x 1.020.XXX (length in mm) 1x 10.062.979 1x 6.036.199 2x 10.030.202 1x 10.030.857		7.127.XXX Arm length (mm)
Wall Mount 128 (without enclosure) - +/- 90° tilt - 90° image rotation - Working distance adjustment - For Colibri enclosures	1x 6.041.144 2x 10.059.296 1x 1.020.XXX (length in mm) 1x 10.062.979 1x 6.036.201 1x 10.062.830		7.128.XXX Arm length (mm)
Wall Mount 129 (without enclosure) - 360° endless pan - +/- 90° tilt - 90° image rotation - Working distance adjustment - For Colibri enclosures	1x 6.041.144 2x 10.059.296 1x 1.020.XXX (length in mm) 1x 10.062.979 1x 6.036.199 2x 10.030.202 1x 10.030.857 1x 6.036.201, 1x 10.062.830		7.129.XXX Arm length (mm)
Pole Mount (without Wall Mount and enclosure) - up to 115mm diameter incl. two stainless steel band clamps - for almost any Wall Mount or Mounting Kit usable	150x16x40mm dovetail profile with two band clamps Surcharge 150x16x40mm profile with two band clamps 150x16x40mm dovetail profile without band clamps		7.100.000 For Wall Mounts 7.100.001 No Band Clamps 7.100.002

Fine Positioning

Benefits:

- Compact design only 16x40mm cross section
- Play-free guidance up to 3Nm rolling moment
- Self-locking
- Low clamping dimension (from 24mm)
- Interchangeable positioning tables
- Scale display in millimeters
- Suitable for industrial and laboratory use
- 150mm stroke
- Feed 1.5mm per revolution
- After fixation, the slide is non-shifting up to 2000N
- Can be combined to any multi-axis arrangement
- Compatible with autoVimation clamps and profiles
- Adaptable to all profile sizes
- Magnetic tape and digital display optional



With transition clamps, the axes can also be used for Colibri and laser housings





Technical Details:

Dimensions	
Vertical mount	265 x 56 x 47mm
Parallel Mount (L x B x H, incl. crank)	265 x 56 x 55mm
Weight	
Vertical mount	425g
Parallel Mount	402g
Base material	Aluminum, anodized
Stroke	150mm
Feed	1.5mm/revolution
Options	- Transition clamps - Digital display



The axes can be combined in any arrangement, play-free guidance up to 3Nm rolling torque is possible

Order Numbers:







Fine Positioning Axis (Please order brackets separately)			
Vertical Mount	Order Number	Parallel Mount	Order Number
	110.040.090		110.040.000
	110.050.090 Display mounted to the slider		110.050.000 Display mounted to the slider
	110.060.090 Display incl. 1m cable		110.060.000 Display incl. 1m cable
	110.060.080 Mounting frame for display		110.060.080 Mounting frame for display
40mm Dovetail	10.040.201	30mm Dovetail (Colibri)	10.062.979
Parallel Slim Bracket	10.044.984	Adapter Bracket 30/40mm	
Orthogonal Bracket		20mm Dovetail (Laser)	10.049.051
		Adapter Bracket 20/40mm	

Fine Adjustment Table		
<p>The little brother of the positioning axes: - +/- 3mm fine positioning in two axes - Separate locking - 40mm dovetail profile</p>		6.045.836

Mounting Brackets

Product	Image	Order Number
Parallel Slim Bracket - Parallel assembly of two dovetail profiles - For 40mm dovetail profile		10.040.201
Parallel Slim Bracket with Hand Knob - Parallel assembly of two dovetail profiles - Tool-free assembly - Perfect for laboratory use - For 40mm dovetail profile		10.054.598
Handle for 40mm Brackets and Angles - To replace standard screws - For tool-free work around - Clamp not included		10.100.002
Parallel Slim Bracket Short - Parallel assembly of two dovetail profiles - For lighter objects - For 40mm dovetail profile		10.041.190
Parallel Wide Bracket - Parallel assembly of two dovetail profiles - For 40mm dovetail profile		10.045.942
Adapter Bracket 30mm to 40mm Dovetail Profile - Parallel assembly of a 30mm dovetail profile (Colibri) with a 40mm dovetail profile		10.062.979
Adapter Bracket 20mm to 40mm Dovetail Profile - Parallel assembly of a 20mm dovetail profile (Laser enclosure) with a 40mm dovetail profile		10.049.051



Product	Image	Order Number
Orthogonal Bracket <ul style="list-style-type: none">- Vertical assembly of two dovetail profiles- For 40mm dovetail profile		10.044.984
Tilt Adjustment Bracket <ul style="list-style-type: none">- +/- 8° tilt- For 40mm dovetail profile		10.054.638
40mm Rotational Mounting Bracket <ul style="list-style-type: none">- 360° rotation in combination with Rotational Disk- For 40mm dovetail profile		10.040.202
Rotational Disc for 40mm Rotational Bracket <ul style="list-style-type: none">- 360° rotation in combination with Rotational Mounting Bracket		10.040.857
Rotational Double Joint <ul style="list-style-type: none">- 360° rotation- For 40mm dovetail profile		10.040.860
Repeatable Position Bracket <ul style="list-style-type: none">- Accurate re-positioning of camera enclosures- Enables the use of one camera in several positions without re-adjustment- For 40mm dovetail profile		10.044.421
Ground Contact Bracket <ul style="list-style-type: none">- 40mm dovetail profile		10.054.960

Angles









Product	Image	Order Number
Angle Small - For light mechanical stress - For 40mm dovetail profile		10.044.607
Angle Medium - For medium mechanical stress - For 40mm dovetail profile		10.059.296
Angle Large - For heavy mechanical stress - For 40mm dovetail profile		10.059.297
45° Angle - For medium mechanical stress - For 40mm dovetail profile		10.045.241
Adapter Angle M8 to Dovetail Profile - For heavy mechanical stress - For assembly to T-slot profiles or any other environment with M8 screws - For 40mm dovetail profile		10.045.715
Adapter Angle 3x Dovetail Profile - For heavy mechanical stress - For 40mm dovetail profile		10.045.716



Product	Image	Order Number
Rotational Adjustment Angle - Multi-axle, endless 360° rotation - Usable in combination with Rotational Bracket Product Number: 10.040.202 - For 40mm dovetail profile		10.045.852

Product	Image	Order Number
40mm Adapter Plate for 2x M6 CSK Screws - 40mm dovetail profile		6.041.142
64mm Adapter Plate for 2x M6 CSK Screws - 40mm dovetail profile		6.041.141
POM 64mm Adapter Plate with 2x M4 Threads - 40mm dovetail profile - For thermal isolation		6.041.140
PTFE 64mm Adapter for 2x M6 CSK screws - 40mm dovetail profile - For thermal isolation		6.041.143
150mm Adapter Plate for 2x M6 CSK Screws - 40mm dovetail profile		6.041.144
90° Mounting Plate - 40mm dovetail profile		6.046.199
90° Mounting Plate for 2x M6 CSK Screws - 40mm dovetail profile		6.046.200



Adapter Plates/Profiles

Product	Image	Order Number
32mm Adapter Plate for 4x M4 Pan Head Screws - 40mm dovetail profile		6.041.132
64mm Adapter Plate for 4x M4 Pan Head Screws - 40mm dovetail profile		4xM4 6.041.135
64mm Adapter Plate for 8x M4 Pan Head Screws - 40mm dovetail profile		8xM4 6.041.133
Front Adapter 66x66 Profile light (Gecko) - 40mm dovetail profile - Incl. 4x M5 Torx screws		6.036.202
Tripod Mounting Plate - 1/4" and 3/8" threads - 30mm (Colibri) or 40mm dovetail profile		30mm 6.031.935 40mm 6.041.935
Adapter Plate for Manfrotto Superclamp - For flexible mounting Rotational Disk for Manfrotto Superclamp - For flexible mounting - Usable in combination with Rotational Bracket Product Number: 10.040.202		Adapter Plate 6.041.136 Rotational Disk 6.042.387
Rotational Mounting Disk for 2x M6 CSK Screws - Usable in combination with Rotational Bracket Product Number: 10.040.202		6.042.388
40mm Disk for 4x M4 Pan Head Screws - Usable in combination with Rotational Bracket Product Number: 10.040.202 - Usable also in combination with mounting arm for illumination Product Number: 30.010.175		6.042.386









Product	Image	Length in mm	Order Number
8 x 40mm Dovetail Profile - Single sided dovetail - Weight: 0.73kg/m - $W_x = 0.32\text{cm}^3$ $W_y = 1.36\text{cm}^3$ - Max. length 2000mm - 40mm dovetail		300 500 1000 2000 Individual	1.010.300 1.010.500 1.011.000 1.012.000 1.01X.XXX
12 x 56mm Dovetail Profile - Single sided dovetail - Weight: 1.62kg/m - $W_x = 1.04\text{cm}^3$ $W_y = 4.83\text{cm}^3$ - Max. length 2000mm - 40mm dovetail		300 500 1000 2000 Individual	1.050.300 1.050.500 1.051.000 1.052.000 1.05X.XXX
16 x 40mm Dovetail Profile - Double sided dovetail - Weight: 0.98kg/m - $W_x = 1.03\text{cm}^3$ $W_y = 1.64\text{cm}^3$ - Max. length 2000mm - 40mm dovetail		300 500 1000 2000 Individual	1.020.300 1.020.500 1.021.000 1.022.000 1.02X.XXX
66 x 66mm Light Dovetail Profile - Weight: 2.19kg/m - $W_x = W_y = 13.00\text{cm}^3$ - Max. length 2000mm - 40mm dovetail		300 500 1000 2000 Individual	1.070.300 1.070.500 1.071.000 1.072.000 1.07X.XXX
66 x 66mm Stable Dovetail Profile - Weight: 4.00kg/m - $W_x = W_y = 23.00\text{cm}^3$ - Max. length 2000mm - 40mm dovetail		300 500 1000 2000 Individual	1.040.300 1.040.500 1.041.000 1.042.000 1.04X.XXX
96 x 96mm Stable Dovetail Profile - Weight: 4.77kg/m - $W_x = W_y = 37.82\text{cm}^3$ - Max. length 2000mm - 40mm dovetail		300 500 1000 2000 Individual	1.060.300 1.060.500 1.061.000 1.062.000 1.06X.XXX
Cable Channel - Snap on - Weight: 0.549kg/m - Max. length 2000mm - 40mm dovetail		300 500 1000 2000 Individual	1.080.300 1.080.500 1.081.000 1.082.000 1.08X.XXX

Adapter Plates and Brackets for 30mm Dovetail

Product	Image	Order Number
Parallel Slim Bracket 30mm - Parallel assembly of two dovetail profiles - For 30mm dovetail profile		10.062.830
90° Mounting Plate - 30mm dovetail profile		6.036.199
30mm Rotational Mounting Bracket - 360° rotation in combination with 30mm Rotational Disk - For 30mm dovetail profile		10.030.202
Rotational Disc for 30mm Rotational Bracket - 360° rotation in combination with 30mm Rotational Mounting Bracket		10.030.857
Disc for 30mm Rotational Bracket and 2x M6 CSK - 360° rotation in combination with 30mm Rotational Mounting Bracket Product Number: 10.030.857		6.032.388
180° Joint - +/- 90° tilt - 30mm dovetail profile		6.036.201
Step Down Profile 30mm to 40mm Dovetail - Adapter profile		6.240.001



Product	Image	Order Number
Front Adapter Colibri with 30mm Dovetail <ul style="list-style-type: none">- 30mm dovetail profile- Incl. 4x M5 Torx screws		6.036.200
Angle Small for 30mm Dovetail Profile <ul style="list-style-type: none">- For light mechanical stress- For 30mm dovetail profile		10.034.607
Angle Medium for 30mm Dovetail Profile <ul style="list-style-type: none">- For medium mechanical stress- For 30mm dovetail profile		10.039.296
10 x 44mm Dovetail Profile <ul style="list-style-type: none">- Single sided dovetail- Weight: 1.06kg/m- $W_x = 0.54\text{cm}^3$ $W_y = 2.51\text{cm}^3$- Max. length 2000mm- 30mm dovetail		1.10X.XXX Length in mm
6 x 30mm Dovetail Profile <ul style="list-style-type: none">- Single sided dovetail- Weight: 0.411kg/m- $W_x = 0.138\text{cm}^3$ $W_y = 0.574\text{cm}^3$- Max. length 2000mm- 30mm dovetail		1.11X.XXX Length in mm
12 x 30mm Dovetail Profile <ul style="list-style-type: none">- Double sided dovetail- Weight: 0.488kg/m- $W_x = 0.476\text{cm}^3$ $W_y = 0,991\text{cm}^3$- Max. length 2000mm- 30mm dovetail		1.12X.XXX Length in mm
50 x 50mm Dovetail Profile <ul style="list-style-type: none">- Weight: 1.53kg/m- $W_x = 7.20\text{cm}^3$ $W_y = 7.20\text{cm}^3$- Max. length 2000mm- 30mm dovetail		1.09X.XXX Length in mm

Mounting Blocks

Benefits:

- Robust and cost-effective camera mount
- Perfect where no overall IP protection is required
- Good heat dissipation
- Flexible mounting options
- Camera mount included



Technical Details:



Salamander Mounting Block	
Profile Material	Anodized Aluminum
Dimensions (w x h x l) 60mm Block 100mm Block 164mm Block	66 x 66 x 60mm 66 x 66 x 100mm 66 x 66 x 164mm
Weight 60mm Block 100mm Block 164mm Block (without camera mount)	272g 426g 698g
Order Number 60mm Block 100mm Block 164mm Block (specify camera type)	15.010.060 15.010.100 15.010.164

Orca Mounting Block	
Profile Material	Anodized Aluminum
Dimensions (w x h x l)	96 x 96 x 80mm
Weight (without camera mount)	384g
Order Number (specify camera type)	15.030.080



Assembly example



Benefits:

- Onboard flash controller
- Designed for the integration into Orca/Shark enclosures with 3" window
- Flashing with up to 570% nominal current possible
- Excellent heat dissipation
- Colors: R, G, B, IR, white
- Radiation angles: 14°, 23°, 36°, 76°
- Trigger in-/output
- LED protection due to emergency shut down
- Temperature monitoring possible
- Easy programming due to intuitive application surface



Technical Details:

Operating voltage	24VDC (+-10%)	Pulse Width	50µs - 650ms 10µs steps
Max. Power @permanent operation	12W	Max. Pulse Frequency	1000Hz
Nominal LED Current	350m@100% amplitude	Max. Pulse Delay	10µs
Amplitude Range	50 - 200% (continuous) 50 - 570% (flash)	Max. Jitter Delay	2µs
Trigger Voltage	5-24VDC	Dimensions (d x l)	84.8 x 31mm
Trigger Input Current	10mA	Inner Diameter	36mm
Programming Interface	rs232@9600Baud (TTL level)	Weight	Approx. 150g

Color	Wave Length	Light Current	Light Efficiency	LED Type
Red	623nm	600mW	59%	OSLON SSL80 LR CQ7P
Green	528nm	90lm	87lm/W	OSLON SSL80 LT CQ7P
Blue	470nm	28lm	25lm/W	OSLON SSL80 LB CQ7P
IR	850nm	770mW@1.65W	n/a	SFH 4715A
White 1	4000K	104lm	104lm/W	OSLON GW CS8PM1.CM- KULQ-XX55-1-350-R18

Meganova Ringlight



Meganova User Interface



Thanks to a housing adapter, the Meganova can also be used in the Salamander enclosure

Order Numbers:

LED Color	Radiation Angle	Order Number
Red	14°	36.634.014
	23°	36.634.023
	36°	36.634.036
	76°	36.634.076
Green	14°	36.521.014
	23°	36.521.023
	36°	36.521.036
	76°	36.521.076
Blue	14°	36.465.014
	23°	36.465.023
	36°	36.465.036
	76°	36.465.076

LED Color	Radiation Angle	Order Number
White 1	14°	36.450.014
	23°	36.450.023
	36°	36.450.036
	76°	36.450.076
IR	14°	36.860.014
	23°	36.860.023
	36°	36.860.036
	76°	36.860.076

Cables	Order Number
5m Power/Trigger, angled connector	36.200.010
5m Programming, angled connector	36.200.020
5m Power/Trigger, shielded, straight	36.200.031
5m Programming, straight connector	36.200.040

Product	Image	Order Number
Diffuser Ring for Meganova - Low diffuse, 82% transm.		36.300.001
Diffuser Ring for Meganova - High diffuse, 45% transm.		36.300.002
Meganova Polarizing Ring 42% transmission		36.350.001
Polarizing Disk for Camera 42% transmission		36.350.002

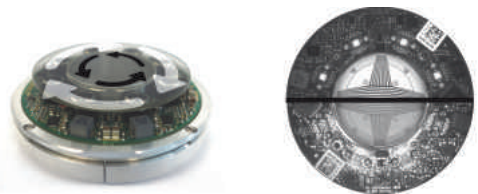

You can eliminate reflections by twisting the polarizing ring/disk against each other. Comparison with and without twisted polarizing disk and ring.



Benefits:

- Universal plate to mount ring lights into Orca enclosures
- 34mm inner diameter
- For flashing only



Technical Details:

Spider Ring Light Adapter Plate		Mounting Holes	4x 2.2mm
Dimensions (d x h)	85 x 2mm	Weight	15g
Inner Diameter	34mm	Order Number	30.160.010



Technical Details:

Mounting Arms		Mounting Arms	
Dimensions (l x w x h)	175 x 40 x 8mm	Dimensions (l x w x h)	200 x 40 x 8mm
Front Threads	2x M4	Threads (for disk Order Number: 6.042.386)	4x M4
Weight	126g	Weight	144g
Order Number	30.009.175	Order Number	30.010.175

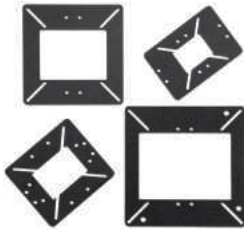

Spider Adapter Plate		
Type	Size	Order Number
Spider 1, M4	70 x 98mm	30.150.011
Spider 2, M4	90 x 98mm	30.150.021
Spider 3, M4	120 x 120mm	30.150.031
Spider 4, M4	144 x 144mm	30.150.041

Spider 1

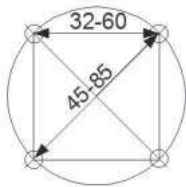

Aperture: 40 x 30mm

Spider 2



54 x 40mm

Spider 3

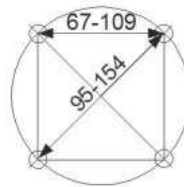

80 x 60mm

Spider 4

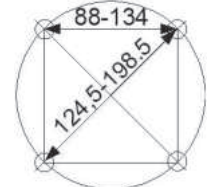

110 x 80mm



The Albatross can also be used as an universal camera mounting plate



Albatross Adapter Plate		
Type	Size	Order Number
Albatross 1, M3	40 x 58mm	30.200.010
Albatross 1, M4		30.200.011
Albatross 2, M4	40 x 128mm	30.200.021
Albatross 3, M4	40 x 158mm	30.200.031



Product	Image	Order Number	Product	Image	Order Number
Allen Key 4mm, - T-handle - Length = 100mm		90.000.002	Mounting Tool with 4mm pins for Orca and Feuersalamander lids		90.000.004
Allen Key 4mm, - T-handle - Length = 150mm		90.000.008	Spreading Pliers, - helpful for cable inserts		90.000.011
Allen Key 3mm, - T-handle - Length = 150mm		90.000.003	Adjustor, tool for fine adjustment of the rotation angle of an enclosure		90.000.005
Allen Key 3mm, - T-handle - Length = 200mm		90.000.006	Ratched Wrench AF10 - 72 teeth - 5° movement		90.000.009
Allen Key 3mm, - T-handle - Length 350mm		90.000.007	TX20H bit, - for tamper-proof screws with Torx pin		90.000.010
Allen Key 2.5mm, - T-handle - Length = 100mm		90.000.012	Shark Mounting Tool - for lid assembly		80.006.101
Circlip Pliers (Shark, Dolphin, Feuersalamander) - for window exchange		90.000.017	Torx screwdriver with 250mm blade length for Alignment Tool Orca		90.000.016

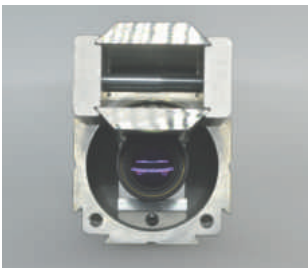

The Alignment-Tool makes a straight camera integration easier

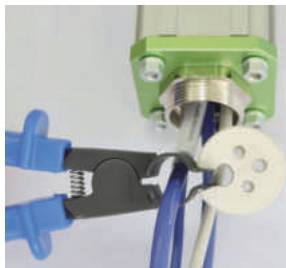

The Spreading Pliers are helpful to insert cables into the cable gland insert

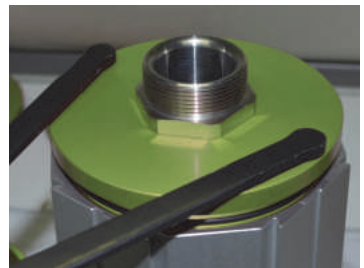

The Mounting Tool helps to tighten the front and back lids

Benefits:

- Application specific windows ex works:
- Germanium or Sapphire: thermal imaging
- BK7 standard: robust glass with high transmission
- IR mirror: applications in critical temperatures
- Acrylic: food industry
- Special windows on request



Product	Image	Order Number
30mm glass window (H-K9L), double-sided AR coated		20.000.030
30mm Sapphire window, 0.2 - 5.5µm, uncoated		20.000.031
30mm Germanium window, 7 - 14µm, DLC + AR coated		20.000.095
30mm acrylic window, FDA, no coating		20.000.112
30mm dome window, BK7, uncoated		20.000.093
2" glass window (H-K9L), double-sided AR coated		20.000.013
2" Sapphire window, 0.2 - 5.5µm, uncoated		20.000.053
2" Germanium window, 7 - 14µm, DLC + AR coated		20.000.054
2" Acrylic window, FDA, uncoated		20.000.058
2" Acrylic window, double-sided AR coated		20.000.029
2" IR mirror (heat reflecting glass)		20.000.052



Product	Image	Order Number
3" glass window (H-K9L), double-sided AR coated		20.000.035
3" Germanium window, 7 - 14μm, DLC + AR coated		20.000.055
3" Acrylic window, FDA, uncoated		20.000.002
3" Acrylic window, double-sided AR coated		20.000.059
3" IR mirror (heat reflecting glass)		20.000.065
3" Dome glass window (H-K9L), uncoated		20.000.004
4" glass window (H-K9L), double-sided AR coated		20.000.066
UV filter 72mm (e.g. for M72 Orca front lid as additional protection glass)		20.000.096

Please ask for other window materials if necessary. Thanks to the Orca front cover with M72 thread, standard filters or sun shades from the photo area can also be combined with different housing types.





Front Lid

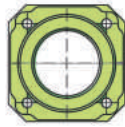
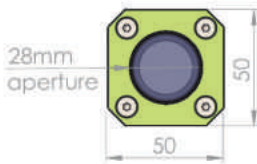

max. 39mm lens diameter

Profile



Dome Lid



max. 25mm lens diameter

Size XS

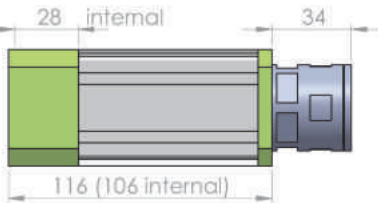

Size S

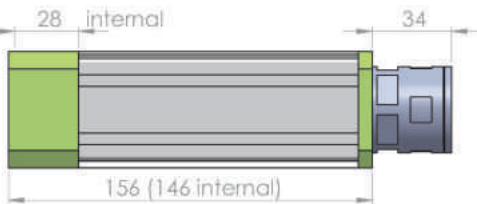

Rear Wall A

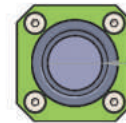

max. 20mm connector

Size M

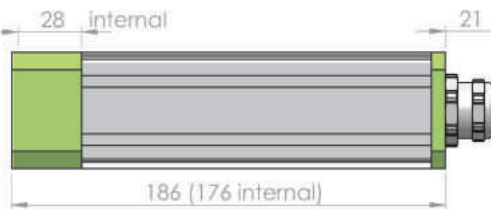

Rear Wall B

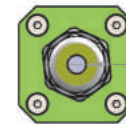

max. 13.5mm connector
4 - 6.5mm cable

Size M

Flat Front Lid

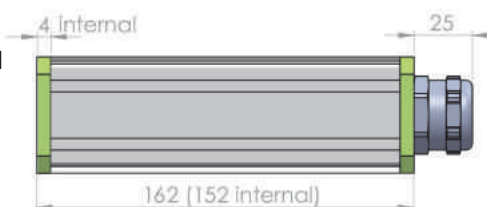

Rear Wall C

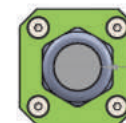

max. 20mm connector
several cables



Front Lid

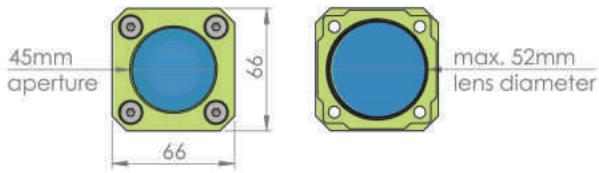

Profile

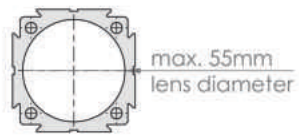

Size XS

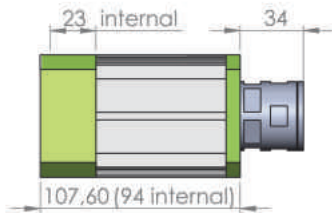

Rear Wall A



Size S

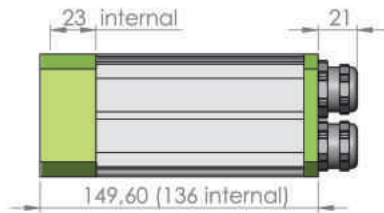

Rear Wall B



Size M

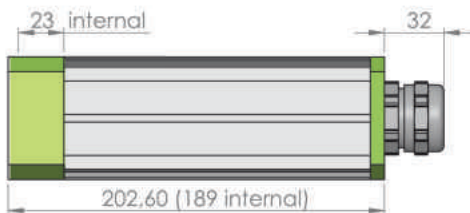

Rear Wall C



Size L

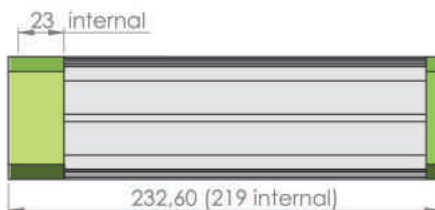

Rear Wall D

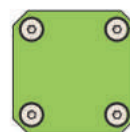



Front Lid

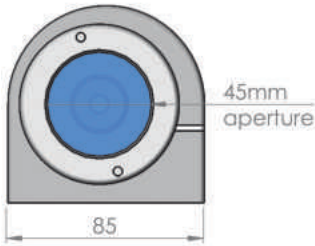

Profile



Size S

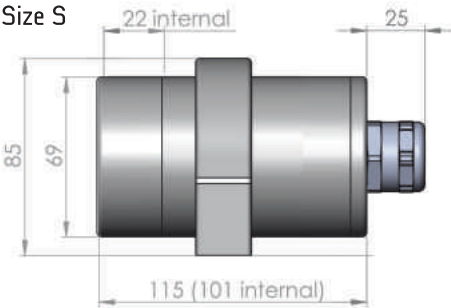

Rear Wall

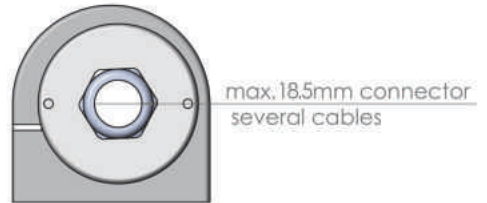

Size M

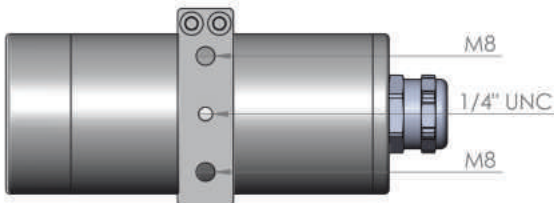
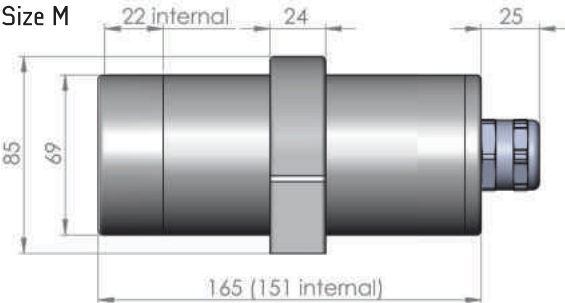



Size S

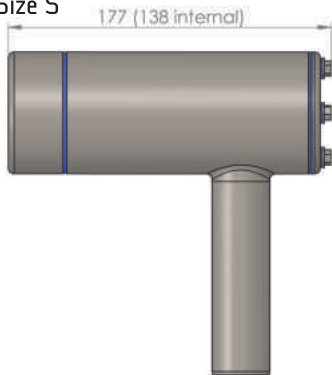

Size M

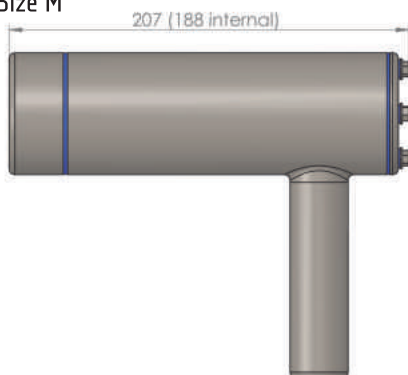

Size L

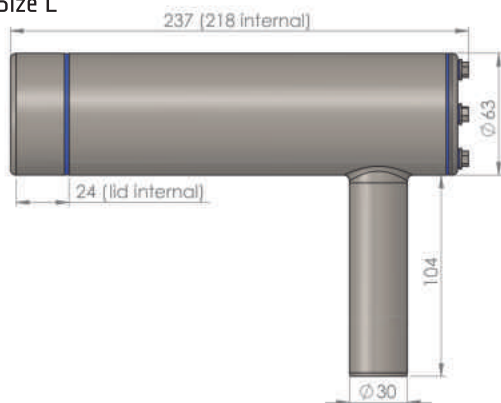

Front Lid

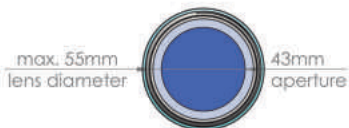

Options for Side Exit

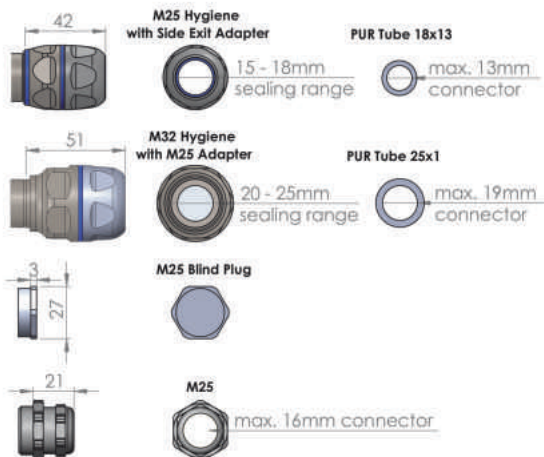

Options for Rear Exit





Size S

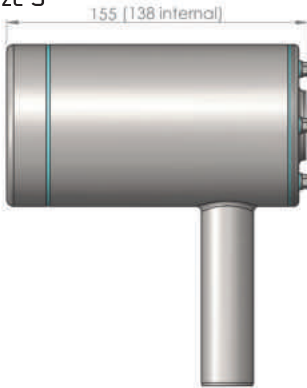

Front Lid

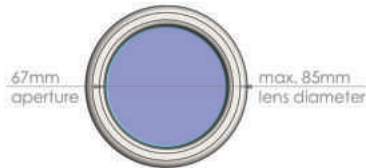

Size M



Options for Side Exit

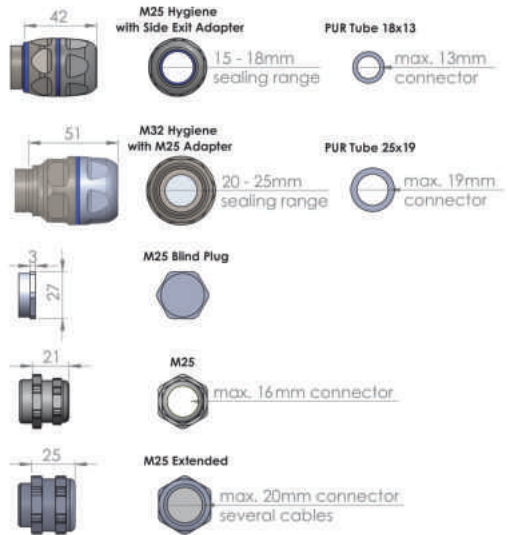

Size L

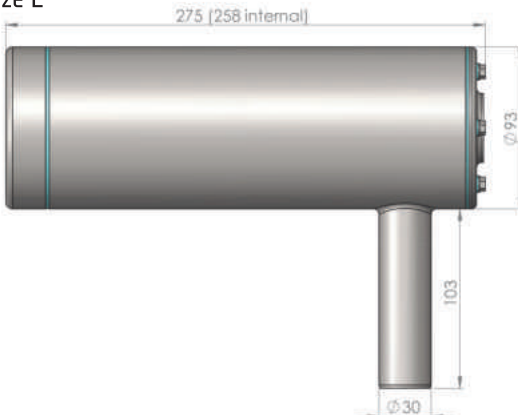

Options for Rear Exit





Front Lid

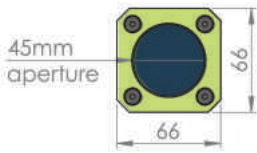

Profile

max. 55mm lens diameter

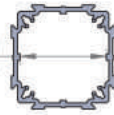

Rear Wall A

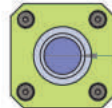

Rear Wall C

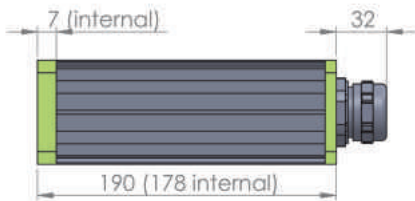
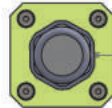

Nautilus Drawings

Front Lid

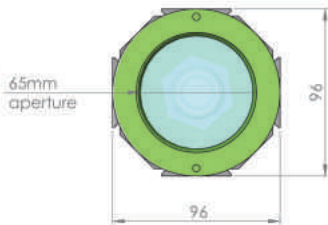

Profile

max. 85mm lens diameter

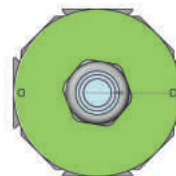
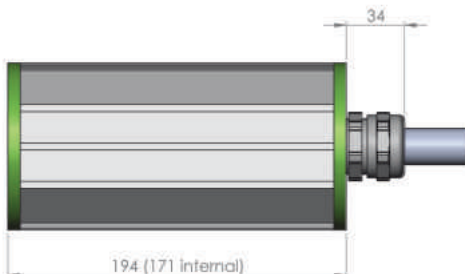



2" Front Lid

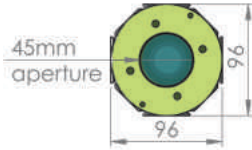

3" Front Lid

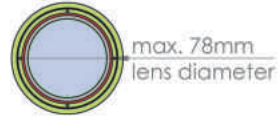
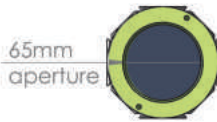

Dome Front Lid

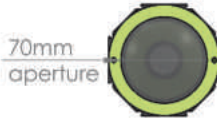

Profile



Size S

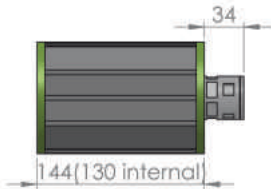

Rear Wall A



Size M

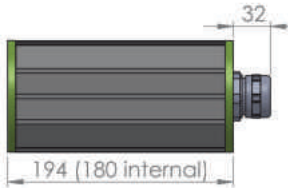

Rear Wall C



Size L



Rear Wall D

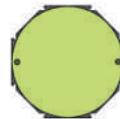

Size XL

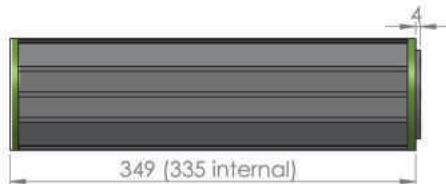

Rear Wall E





Twin Window

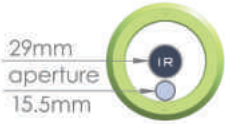

3" Window



Profile

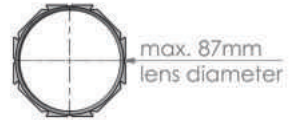

Megalodon

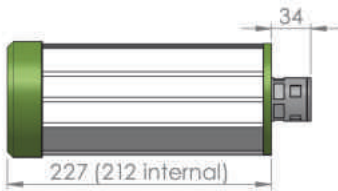

Rear Wall A



Megalodon Reverse

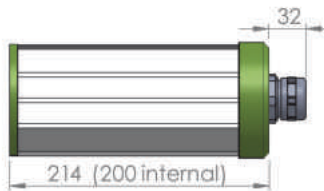

Rear Wall C



3" Window

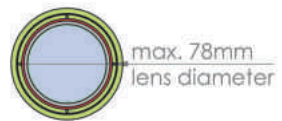
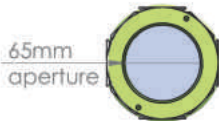

Dome Front Lid



Profile





3" Window

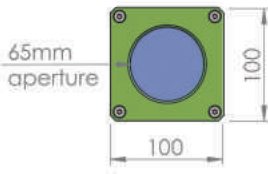

Profile

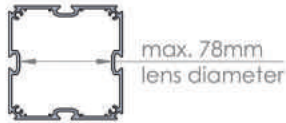

Stingray S

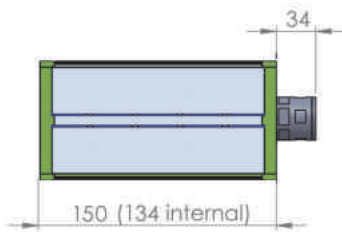

Rear Wall A



Stingray M

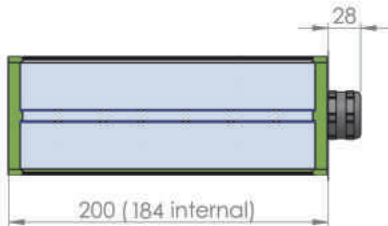

Rear Wall C



Stingray L Flange

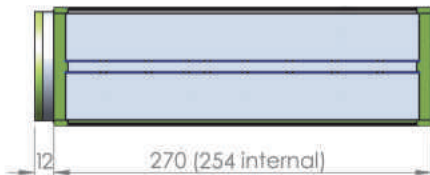



3" Window

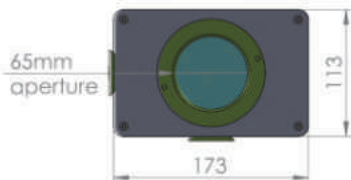

Profile



Mammoth L

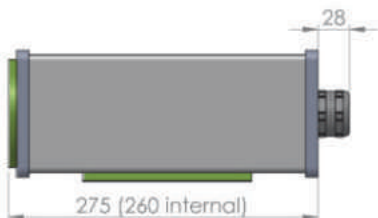

Rear Wall C



3" Window

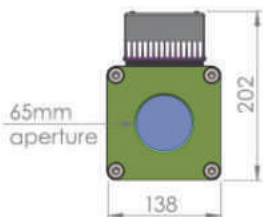

4" Window

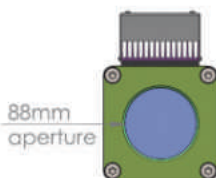

Profile

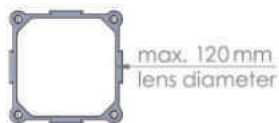

Turtle M/MiC

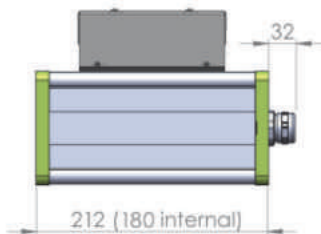

Rear Wall C



Turtle L/LiC Flange

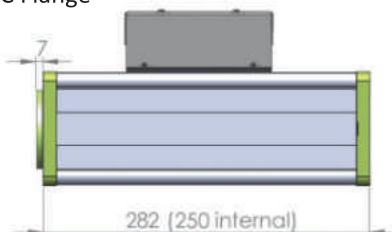



3" Window

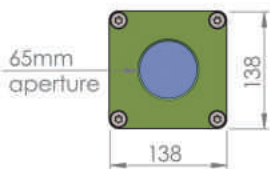

4" Window

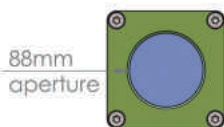

Profile

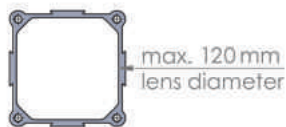

Elephant S

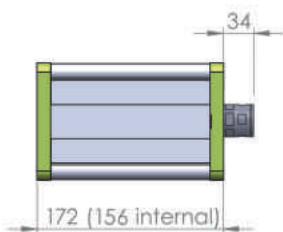

Rear Wall A



Elephant M

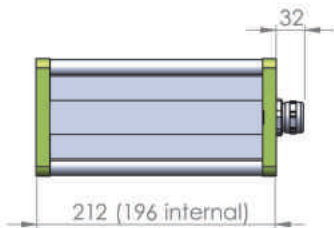

Rear Wall C



Elephant L Flange

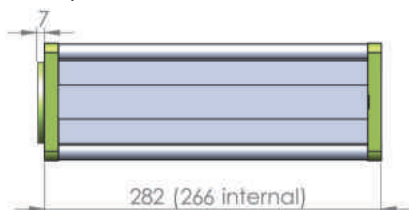

Rear Wall D

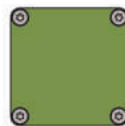



Size S

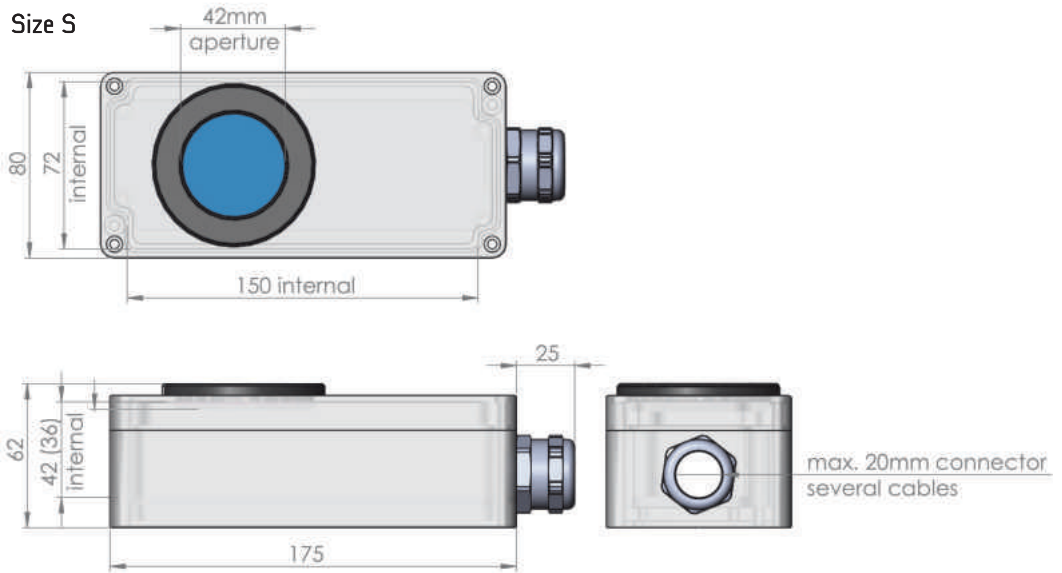

Size ST



Size Ax8



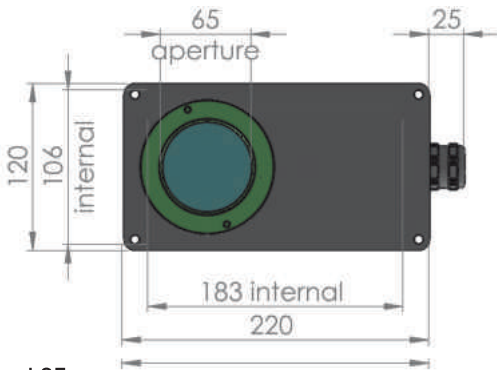

Size L65

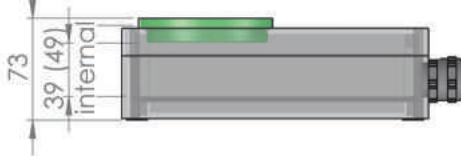

max. 20mm connector
several cables.

Size L75

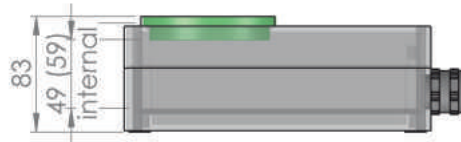

Size L80

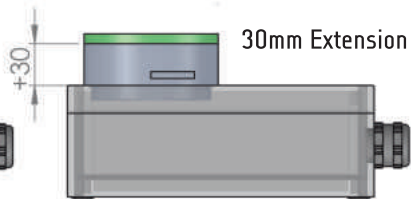
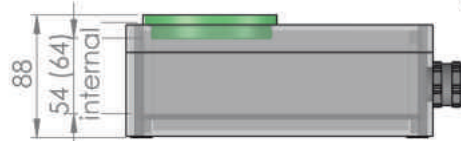

30mm Extension

Size L90

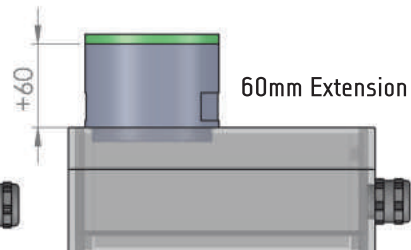

60mm Extension



D415

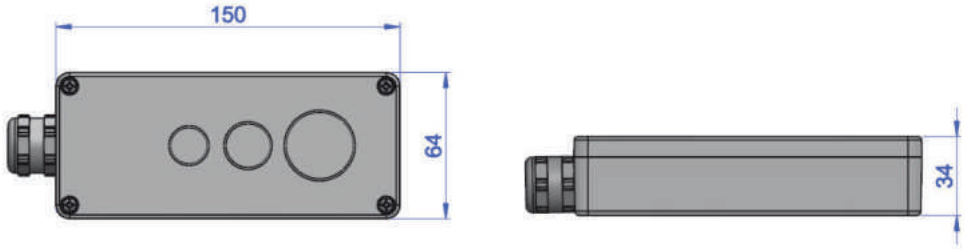

D435

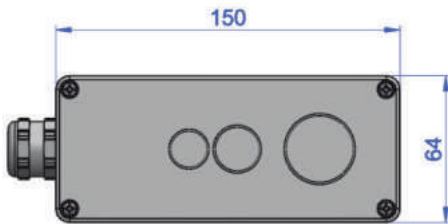

D455

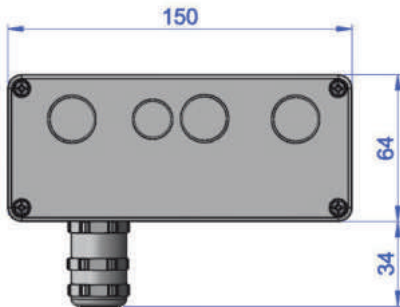

T265 (discontinued)

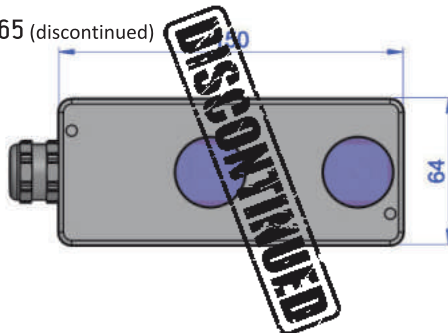



Chameleon FX Drawings

Chameleon FX

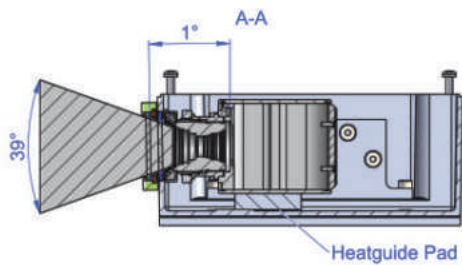
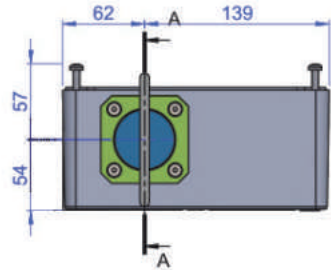
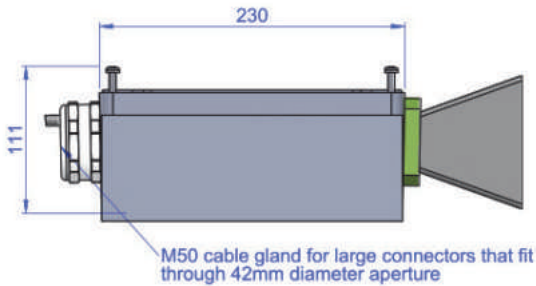

Chameleon FX Hygienic

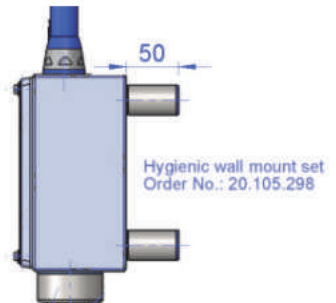
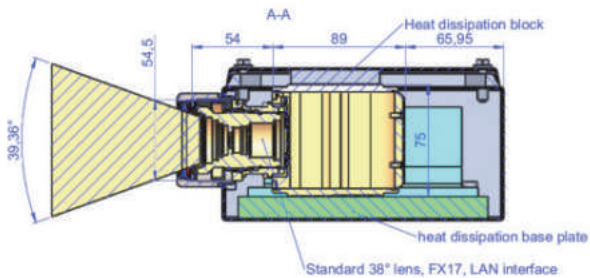
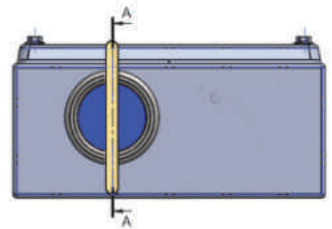
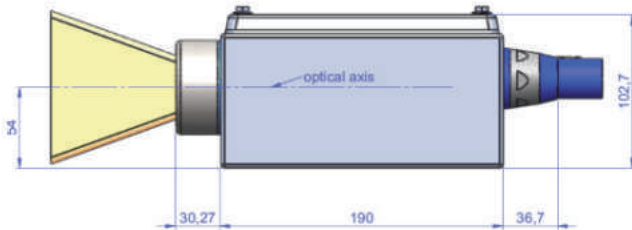

Vertical Mount

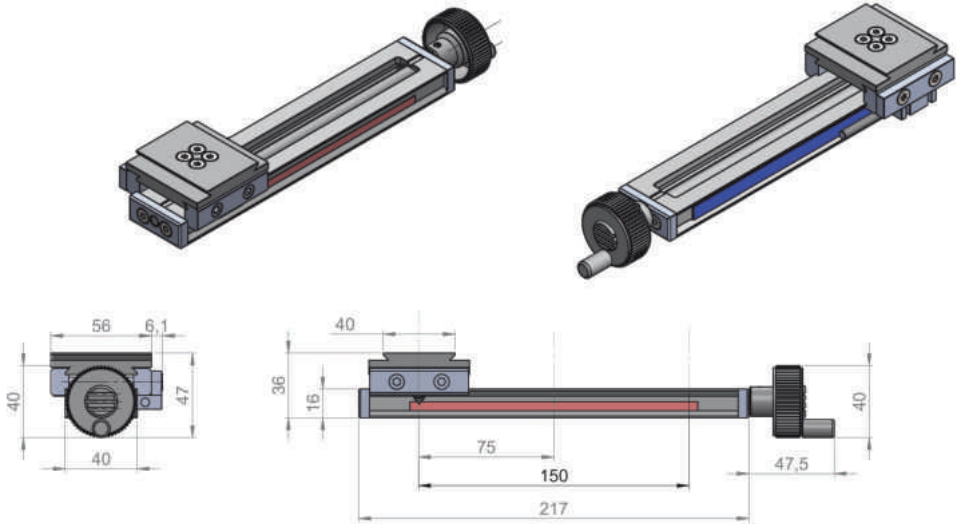

Parallel Mount

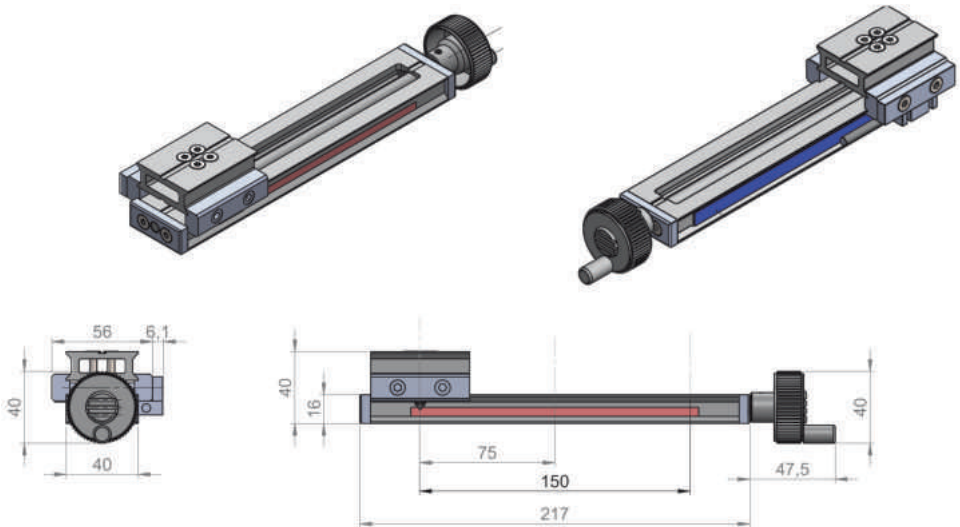

Transmittance Diagrams Front Windows

Standard BK7 Window - double sided anti-reflexion coating

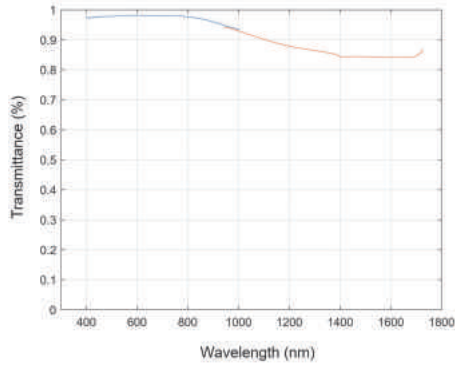

Acrylic Window - double sided anti-reflexion coating

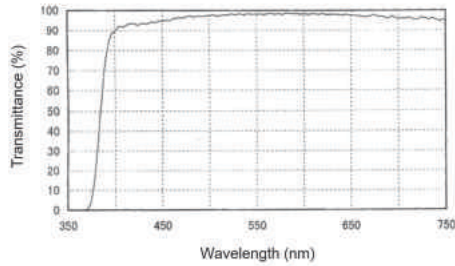

Germanium Window - DLC + anti-reflexion coating

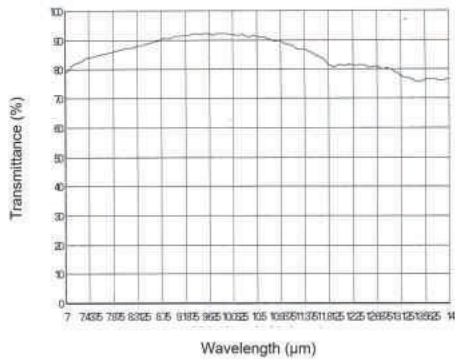



Solid particle protection

The first digit indicates the level of protection that the enclosure provides against access to hazardous parts.

Level (1st digit)	Effective against	Description
5	Dust protected	Ingress of dust is not entirely prevented, but it must not enter in sufficient quantity to interfere with the satisfactory operation of the equipment.
6	Dust tight	No ingress of dust; complete protection against contact (dust tight). A vacuum must be applied. Test duration of up to 8 hours based on air flow.

Liquid ingress protection

The second digit indicates the level of protection that the enclosure provides against harmful ingress of water.

Level (2nd digit)	Effective against	Description
4	Splashing of water	Water splashing against the enclosure from any direction shall have no harmful effect, utilizing either: a) an oscillating fixture, or b) A spray nozzle with no shield, Test duration: 10min.
5	Water jets	Water projected by a nozzle (6.3 mm) against enclosure from any direction shall have no harmful effects. Test duration: 15min, 12.5l/min @30kPa at 3m distance.
6	Powerful water jets	Water projected in powerful jets (12.5 mm nozzle) against the enclosure from any direction shall have no harmful effects. Test duration: 3min, 100l/min @100kPa at 3m distance.
6K	Powerful water jets with increased pressure	Water projected in powerful jets (6.3 mm nozzle) against the enclosure from any direction, under elevated pressure, shall have no harmful effects (DIN 40050, not IEC 60529). Test duration: 3min, 75l/min@1000kPa at 3m distance.
7	Immersion up to 1m depth	Ingress of water in harmful quantity shall not be possible when the enclosure is immersed in water under defined conditions of pressure and time. Test duration: 30min, 1m below water surface.
8	Immersion 1m or more depth	The equipment is suitable for continuous immersion in water. Water can enter in such a manner that it produces no harmful effects. Manufacturer specified duration and water depth (>IPx7, 3m typical).
9K	Powerful high temperature water jets	Protected against close-range high pressure/temperature spray downs. Test duration: 30s each of four angles, spray nozzle with 80°C water at 8–10 MPa (80–100 bar) and a flow rate of 14–16 L/min.

Note: Lower IP ratings are not automatically included in the higher classes, e.g. IP66 is not part of IP67 and IP68/IP69k do not include any other ratings! Testing time and depth of IP68 is specified by the manufacturer (not unlimited time!). Suitable cables have to be used in combination with the cable glands to fulfil the IP protection class.

Chemical Resistance of Sealing Materials

1= very good chemical resistance, 2 = good resistance, 3-4 limited resistance, 5-6 not resistant

This table has been compiled from several sources, the classification may therefore vary and is a general guideline only!
For critical applications please request sealing material samples from autoVimation for testing!

	NBR	VMQ (Silicone)	FKM (Viton)	EPDM	TPE	TPEV	PU-foam (Poron)
temperature (min., max)	-35 ; +100	-40; +200	-20; +200 (230)	-40; +120 (150)	-40; +130	-40; +135 (150)	-40, +90°C
ageing		1	1	1	1	1	1
ozone	4	1	1	1	1	1	1
gas permeability	1	5	1				
suitable for food appl.		1					
water	3	3	2	1	1	1	1
hot water (100°C)	up to 90°C 2	4	3	1			
sea water	2	3	2	2	1	1	1
steam	5	5	5 -only special mixes durable	1			
chlorine	5	4	3	3			
chlorine (gaseous, 20°C)	5	5	3	3	3	3	
hydrocarbons:	2	4	2	5	2	2	
mineral oil	1	3	2	5	2	2	1
petrol	3	5	2	5	3	3	1
diesel	1	3	2	3			1
alcohol			5			2	
ethanol (20°C)	1	1	5 -only special mixes durable	1	1	1	
ketone			5	2			
aceton (100%, 20°C)	5	5	5		3	3	5
ammonia, diluted (10%, 20 °C)	2	3	5		3	3	n.s.
servo steering fluids					5		
break fluids based on Glycol-ether cyclohexane	5	3	5	1	5		n.s.
Acids:				2			
acetic acid 30%	4	4	4	3			n.s.
acetic acid 50%	5	5	5	3			n.s.
acetic acid (100%, 20°C)	5	5	5	5	2	2	n.s.
silicic acid, diluted, 60 °C	2	4	2	2			
phosphoric acid, diluted (20°C)	5	up to 85% 2			bis 85% 2	bis 85% 2	
nitric acid, concentrated.	5	5	5	5			5
nitric acid, diluted (50%, 20 °C)	3	bis 10% 3	3	3	up to 30% 2	up to 30% 2	5
hydrochloric acid (20 °C)	5	5	2	2			5
Hydrochloric acid, diluted (30%, 20°C)	3	up to 10% 3	2	2	up to 10% 1	up to 10% 1	5
sulfuric acid, concentrated 50°C	5	5	5	2			n.s.
sulfuric acid, diluted (20°C)	5	up to 10% 1	2	2	up to 98% 1	up to 98% 1	n.s.
citric acid (up to 10%, 40°C)	up to 20°C 2	5	5 -only special mixes durable	1	2	2	
Bases:				2			
caustic soda, diluted, (10%, 20°C)	3	up to 30% 2	5	2	up to 50% 2	up to 50% 2	n.s.
bleaching lye (20 °C)	5	3					
potassium hydroxide, diluted (50%, 20°C)	3	5	5	2	up to 10% 2	up to 10% 2	
soap solution, 20°C	1	4	1	1	1	1	3
suds	up to 90°C 1						3

Use the Enclosure Configurator on our website!

Enclosures

Enclosures overview

Enclosure configurator

Colibri

Salamander

Feuersalamander

Dolphin

Gecko

Orca

Nautilus

Shark

Mammoth

Chameleon

Turtis

Protective laser enclosures

ENCLOSURE CONFIGURATOR

- Type in camera and lens size and connector length

- Select an enclosure type

- Select a rear wall (if available)

- Select window size and type (if available)

- Select accessories

The configurator is not working with Internet Explorer and requires Java. We do not accept liability for incorrect orders due to software bugs.

Camera height (mm)	Camera width (mm)	Camera length (mm)	Edge radius (mm)
29	29	40	2
Lens diameter (mm)	Lens length (mm)	Connector length (mm)	
29	40	50	
Total length (mm)	Max. diameter (mm)		
130	39,36		

Enclosure Selection

Enclosure type	Size	Select PDF	Rear wall A	Rear wall B	Rear wall C	Rear wall D	2" window	3" window
Colibri	S							
Salamander	S							
Feuersalamander	M							
Gecko	XS							
Orca	S							
Nautilus (incl. 3m tube)								
Mammoth	S							
Select			<input type="radio"/>	<input checked="" type="radio"/>	<input type="radio"/>	<input type="radio"/>	<input type="radio"/>	<input type="radio"/>
Product					Order number:			
Colibri S rear wall B					22.901.120			

www.autovimation.com